



UL INTERNATIONAL (UK) LTD  
Kingsland Business Park,  
Unit 1-3 Horizon,  
Wade Rd,  
Basingstoke RG24 8AH,  
United Kingdom.



designated according to Article 29 of the Regulation (EU) No 305/2011 and member of EOTA (European Organisation for Technical Assessment, [www.eota.eu](http://www.eota.eu))

## European Technical Assessment

**ETA 19/0390  
of 23/07/2020**

**Technical Assessment Body issuing the ETA and designated according to Article 29 of the Regulation (EU) No 305/2011: UL International (UK) Ltd**

**Trade name of the construction product**

Bostik FP 340 Pipe Wrap

**Product family to which the construction product belongs**

Fire Stopping and Sealing Product:  
• Penetration Seals

**Manufacturer**

Bostik BV  
Denariusstraat 11  
4903 RC Oosterhout  
The Netherlands

**Manufacturing plant(s)**

A/003

**This European Technical Assessment contains**

67 pages including 1 Annex which forms an integral part of this assessment.

**This European Technical Assessment is issued in accordance with regulation (EU) No 305/2011, on the basis of**

EAD 350454-00-1104, September 2017.

**This version replaces**

ETA 19/0390 issued on 12/07/2019

Translations of this European Technical Assessment in other languages shall fully correspond to the original issued document and should be identified as such.

Communication of this European Technical Assessment, including transmission by electronic means, shall be in full. However, partial reproduction may be made, with the written consent of the issuing Technical Assessment Body. Any partial reproduction has to be identified as such.

## Table of Contents

<b>I.</b>	<b>SPECIFIC PARTS OF THE EUROPEAN TECHNICAL ASSESSMENT</b>	<b>3</b>
1	Technical description of the product	3
2	Specification of the intended uses of the product in accordance with the applicable European Assessment Document (Hereinafter EAD): EAD 350454-00-1104	3
3	Performance of the product and references to the methods used for its assessment	5
4	ASSESSMENT AND VERIFICATION OF CONSTANCY OF PERFORMANCE (HEREINAFTER AVCP) SYSTEM APPLIED, WITH REFERENCE TO ITS LEGAL BASE	6
5	Technical details necessary for the implementation of the AVCP system, as provided for in the applicable EAD	6
6	Issued on:	7
	<b>ANNEX A – Resistance to Fire Classification – Bostik FP 340 Pipe Wrap</b>	<b>8</b>
A.1	Rigid wall constructions with wall thickness of minimum 150 mm	8
A.1.1	Bostik FP 340 Pipe Wrap penetration seals, in 100 mm thick Bostik FP 370 Fireseal Mortar seals in rigid walls with insulated metal pipes	8
A.1.2	Bostik FP 340 Pipe Wrap penetration seals, in 100 mm thick Bostik FP 370 Fireseal Mortar seals in rigid walls with plastic pipes	11
A.2	Rigid floor constructions with a minimum thickness 150 mm	12
A.2.1	Bostik FP 340 Pipe Wrap penetration seals, in 100 mm thick Bostik FP 370 Fireseal Mortar seals in rigid floors, with insulated metal pipes	12
A.2.2	Bostik FP 340 Pipe Wrap penetration seals, in 100 mm thick Bostik FP 370 Fireseal Mortar seals in rigid floors, with insulated metal pipes	14
A.2.3	Bostik FP 340 Pipe Wrap penetration seal for insulated metal pipes, in Bostik FP 370 Fireseal Mortar Seal, in rigid floors	16
A.2.4	Bostik FP 340 Pipe Wrap penetration seals, in 100 mm deep Bostik FP 370 Fireseal Mortar seals in rigid floors, with plastic pipes	19
A.2.5	Bostik FP 340 Pipe Wrap penetration seals, in 100 mm thick Bostik FP 370 Fireseal Mortar seals in rigid floors, with plastic pipes	23
A.2.6	Bostik FP 340 Pipe Wrap penetration seals, in Bostik FP 370 Fireseal Mortar seals in rigid floors, with plastic pipes	27
A.2.7	Bostik FP 340 Pipe Wrap penetration seals, in 150 mm thick Bostik FP 370 Fireseal Mortar seals in rigid floors, with plastic pipes	34
A.2.8	Bostik FP 340 Pipe Wrap penetration seals, in 50 mm deep Bostik FP 370 Fireseal Mortar seals, backed with 50 mm stone wool, in rigid floors, with plastic pipes	38
A.3	Flexible and rigid wall constructions with a minimum thickness 100 mm	39
A.3.1	Bostik FP 340 Pipe Wrap penetration seal for insulated metal pipes, in seals comprising 25 mm deep Bostik FP 370 Fireseal Mortar to both faces backed with 50 mm mineral fibre board, installed within flexible or rigid wall	39
A.3.2	Bostik FP 340 Pipe Wrap penetration seal for composite pipes, in seals comprising 25 mm deep Bostik FP 370 Fireseal Mortar to both faces backed with 50 mm mineral fibre board, installed within flexible or rigid wall	41
A.3.3	Bostik FP 340 Pipe Wrap penetration seal for insulated metal & composite pipes, in seals comprising 25 mm deep Bostik FP 370 Fireseal Mortar to both faces backed with 50 mm mineral fibre board, installed within flexible or rigid wall	42
A.3.4	Bostik FP 340 Pipe Wrap penetration seal for insulated metal pipes, in seals comprising 50 mm deep Bostik FP 370 Fireseal Mortar to both faces, installed within flexible or rigid wall	43
A.4	Rigid wall constructions with floor thickness of minimum 150 mm	45
A.4.1	Bostik FP 340 Pipe Wrap penetration seal for insulated metal pipes, in 1x Bostik FP 320 Fire Batt 2-S seals, in rigid walls	45
A.4.2	Bostik FP 340 Pipe Wrap penetration seal for insulated metal pipes, in 2x Bostik FP 320 Fire Batt 2-S seals, in rigid walls	46
A.5	Rigid floor constructions with floor thickness of minimum 150 mm	48
A.5.1	Bostik FP 340 Pipe Wrap penetration seal for plastic pipes, in 1x Bostik FP 320 Fire Batt 2-S, in rigid floors	48
A.5.2	Bostik FP 340 Pipe Wrap penetration seal for insulated metal pipes, in 1x Bostik FP 320 Fire Batt 2-S, in rigid floors	49
A.5.3	Bostik FP 340 Pipe Wrap penetration seal for insulated metal pipes in 2x Bostik FP 320 Fire Batt 2-S (separated), in rigid floors	50
A.5.4	Bostik FP 340 Pipe Wrap penetration seal for insulated metal pipes, in 2x Bostik FP 320 Fire Batt 2-S (back to back), in rigid floors	51
A.6	Flexible wall constructions according to 2. 1)	53
A.6.1	Bostik FP 340 Pipe Wrap penetration seal for insulated metal pipes, in 2x Bostik FP 320 Fire Batt 1-S in flexible or rigid walls	53
A.6.2	Bostik FP 340 Pipe Wrap penetration seal for insulated metal pipes, in 2x Bostik FP 320 Fire Batt 1-S, in flexible or rigid walls	55
A.6.3	Bostik FP 340 Pipe Wrap penetration seal for insulated metal pipes, in 2x Bostik FP 320 Fire Batt 1-S, in flexible or rigid walls	57
A.6.4	Bostik FP 340 Pipe Wrap penetration seal for insulated metal pipes, in 2x Bostik FP 320 Fire Batt 1-S, in flexible or rigid walls	58
A.6.5	Bostik FP 340 Pipe Wrap penetration seal for plastic pipes, in 2x Bostik FP 320 Fire Batt 1-S, in flexible or rigid walls	59
A.6.6	Penetration seal in Bostik FP 370 Fireseal Mortar seals, in flexible* and rigid walls minimum 100 mm thick	66

## I. SPECIFIC PARTS OF THE EUROPEAN TECHNICAL ASSESSMENT

### 1 Technical description of the product

- 1) Bostik FP 340 Pipe Wrap is a pipe closure device used to form penetration seals where combustible pipes and insulated metal pipes penetrate walls and floors.
- 2) The Bostik FP 340 Pipe Wrap is supplied in Polyethylene bags size according to pipe diameter or supplied in single layer 25 metre rolls. The number of layers necessary are stated in Appendix 1. The wrap is wrapped around the pipe and pushed into the aperture in the separating element/Bostik FP 320 Fire Batt or cast in with Bostik FP 370 Fireseal Mortar.
- 3) The applicant has submitted a written declaration that the product and/or constituents of the product contains no substances which have been classified as dangerous according to Directive 67/548/EEC and Regulation (EC) No. 1272/2008 and listed in the 'indicative list on dangerous substances' of the EGDS – taking into account the installation conditions of the construction product and the release scenarios resulting from there.

In addition to the specific clauses relating to dangerous substances contained in this European Technical Assessment, there may be other requirements applicable to the products falling within its scope (e.g. transposed European legislation and national laws, regulations and administrative provisions). In order to meet the provisions of the Construction Products Regulation, these requirements need also to be complied with, when and where they apply.

- 4) The use category of Bostik FP 340 Pipe Wrap in relation to BWR 3 (Hygiene, health and environment) is IA1, S/W3

### 2 Specification of the intended uses of the product in accordance with the applicable European Assessment Document (Hereinafter EAD): EAD 350454-00-1104

Detailed information and data is given in Annex A.

The intended use of system Bostik FP 340 Pipe Wrap is to reinstate the fire resistance performance of flexible wall and rigid wall and floor constructions, where they are penetrated by services.

- 1) The specific elements of construction that the system Bostik FP 340 Pipe Wrap may be used to provide a penetration seal in, are as follows:

Flexible walls:	The wall must have a minimum thickness of 100 mm and comprise steel studs or timber studs* lined on both faces with minimum 2 layers of 12.5 mm thick boards.
Rigid walls:	The wall must have a minimum thickness of 100 mm and comprise concrete, aerated concrete or masonry, with a minimum density of 650 kg/m <sup>3</sup> .
Rigid floors:	The floor must have a minimum thickness of 150 mm and comprise aerated concrete or concrete with a minimum density of 650 kg/m <sup>3</sup> .

\* no part of the penetration seal may be closer than 100 mm to a stud, the cavity must be closed between the penetration seal and the stud, and minimum 100 mm of insulation of class A1 or A2 according to EN 13501-1 must be provided within the cavity between the penetration seal and the stud.

The supporting construction must be classified in accordance with EN 13501-2 for the required fire resistance period.

- 2) Aperture sizes are given in Appendix A. Under EN 1366-3 rules, results from tests in floors with a penetration seal length of minimum 1000 mm apply to any length as long as the perimeter length to seal area ratio is not smaller than that of the tested penetration seal. The following aperture sizes are therefore allowed where 2400 mm x 1200 mm is described in floors:

Maximum Aperture Sizes within Floors or Between Floors and Walls
1200 mm width x 2400 mm length (tested)
1100 mm width x 2900 mm length
1000 mm width x 4000 mm length
900 mm width x 7000 mm length
≤800 mm width x ∞ (infinite) length

- 3) The system Bostik FP 340 Pipe Wrap may be used to provide a penetration seal with specific supporting constructions and substrates (for details see Annex A).
- 3) The provisions made in this European Technical Assessment are based on an assumed working life of the Bostik FP 340 Pipe Wrap of 25 years, provided that the conditions laid down in the manufacturers datasheet and instructions for the packaging/transport/storage/installation/use/repair are met. The indications given on the working life cannot be interpreted as a guarantee given by the producer, but are to be regarded only as a means for choosing the right products in relation to the expected economically reasonable working life of the works.
- 4) Type X: intended for use at conditions exposed to weathering.

**3 Performance of the product and references to the methods used for its assessment**

Product-type: Pipe Wrap		Intended use: Penetration Seal
Assessment method	Essential characteristic	Product Performance
<b>BWR 2 Safety in case of fire</b>		
EN 13501-1	Reaction to fire	Class F (not tested)
EN 13501-2	Resistance to fire	Annex A
<b>BWR 3 Hygiene, health and environment</b>		
EN 1026	Air permeability	No performance determined
EAD 350454-00-1104, Annex C	Water permeability	No performance determined
Declaration of manufacturer & EN 16516	Content, emission and/or release of dangerous substances	Use categories: IA1, S/W3 Declaration of manufacturer
<b>BWR 4 Safety in use</b>		
EOTA TR 001:2003	Mechanical resistance and stability	No performance determined
EOTA TR 001:2003	Resistance to impact/movement	No performance determined
EOTA TR 001:2003	Adhesion	No performance determined
EAD 350454-00-1104, Clause 2.2.9	Durability	X
<b>BWR 5 Protection against noise</b>		
EN 10140-1,2,4,5/ EN ISO 717-1	Airborne sound insulation	No performance determined
<b>BWR 6 Energy economy and heat retention</b>		
EN 12664, EN 12667, EN 12939, EN ISO 8990, EN ISO 6946, EN ISO 14683, EN ISO 10211, EN ISO 10456	Thermal properties	No performance determined
EN ISO 12572, EN 12086, EN ISO 10456	Water vapour permeability	No performance determined

**4 ASSESSMENT AND VERIFICATION OF CONSTANCY OF PERFORMANCE (HEREINAFTER AVCP) SYSTEM APPLIED, WITH REFERENCE TO ITS LEGAL BASE**

According to the decision 1999/454/EC – Commission Decision of date 22nd June 1999 on the procedure for attesting the conformity of construction products pursuant to Article 20(2) of Council Directive 89/106/EEC as regards fire stopping, fire sealing and fire protective products, published in the Official Journal of the European Union (OJEU) L178/52 of 14/07/1999, see <https://eur-lex.europa.eu/oj/direct-access.html> of the European Commission<sup>1</sup>, as amended, the system(s) of assessment and verification of constancy of performance (see Annex V to Regulation (EU) No 305/2011) given in the following table(s) applies (apply).

<b>Product(s)</b>	<b>Intended use(s)</b>	<b>Level(s) or class(es)</b>	<b>System(s)</b>
Fire stopping and Fire Sealing Products	For fire compartmentation and/or fire protection or fire performance	Any	1

**5 Technical details necessary for the implementation of the AVCP system, as provided for in the applicable EAD**

Tasks of the manufacturer:

Factory production control

The manufacturer shall exercise permanent internal control of production. All the elements, requirements and provisions adopted by the manufacturer shall be documented in a systematic manner in the form of written policies and procedures, including records of results performed. This production control system shall ensure that the product is in conformity with this European Technical Assessment.

The manufacturer may only use initial / raw / constituent materials stated in the technical documentation of this European Technical Assessment.

The factory production control shall be in accordance with the Control Plan of 4<sup>th</sup> June 2018 relating to the European Technical Assessment ETA 19/0390 issued on 23/07/2020 which is part of the technical documentation of this European Technical Assessment. The "Control Plan" is laid down in the context of the factory production control system operated by the manufacturer and deposited at UL International (UK) Ltd.

The results of factory production control shall be recorded and evaluated in accordance with the provisions of the Control Plan.

---

<sup>1</sup> Official Journal of the European Communities L178/52 of 14/7/1999

Other tasks of the manufacturer

Additional information

The manufacturer shall provide a technical data sheet and an installation instruction with the following minimum information:

(a) Technical data sheet:

- Field of application:
- Building elements for which the penetration seal is suitable, type and properties of the building elements like minimum thickness, density, and - in case of lightweight constructions – the construction requirements.
- Limits in size, minimum thickness etc. of the penetration seal
- Construction of the penetration seal including the necessary components and additional products (e.g. backfilling material) with clear indication whether they are generic or specific.

(b) Installation instruction:

- Steps to be followed
- Procedure in case of retrofitting
- Stipulations on maintenance, repair and replacement

**6 Issued on:**

**23<sup>rd</sup> July 2020**

Report by:



D. Yates  
Senior Project Engineer  
Building and Life Safety Technologies

Reviewed by:



C. Johnson  
Staff Engineer  
Building and Life Safety Technologies

**For and on behalf of UL International (UK) Ltd.**

## ANNEX A – Resistance to Fire Classification – Bostik FP 340 Pipe Wrap

### A.1 Rigid wall constructions with wall thickness of minimum 150 mm

#### A.1.1 Bostik FP 340 Pipe Wrap penetration seals, in 100 mm thick Bostik FP 370 Fireseal Mortar seals in rigid walls with insulated metal pipes

**Penetration Seal:** CS (Continuous Sustained) insulated metallic pipes fitted at any position within the aperture (min. separation 10 mm from seal edges), with 100 mm Bostik FP 370 Fireseal Mortar to either side of the wall. Bostik FP 340 Pipe Wraps are required to be centrally within the seal for pipes with combustible insulation. Maximum seal size 2400 mm wide x 1200 mm high.

Construction details:

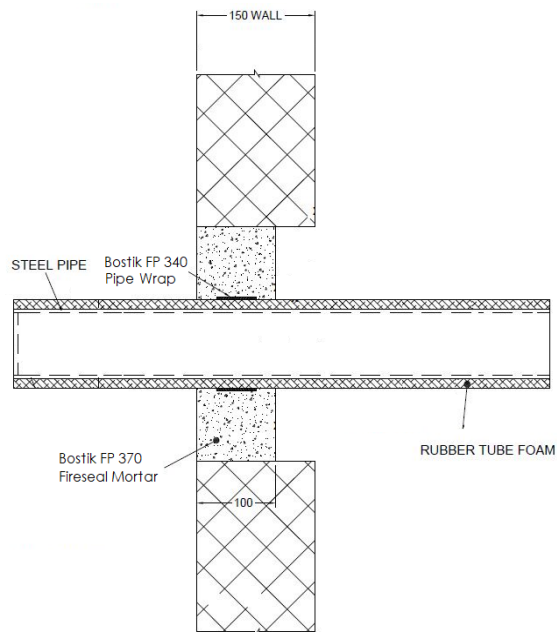



**A.1.1.1**

Services	Wrap	Insulation	Classification
Mild or stainless steel pipe			
40 mm diameter/1.5-14.2 mm wall	1 off 50 x 3.6mm Bostik FP 340 Pipe Wrap, fitted central	13 mm Elastomeric insulation minimum class B-s3,d0 or PE Foam insulation	<b>EI 240 C/U</b>
165 mm diameter/4.5-14.2 mm wall		9 mm Elastomeric insulation minimum class B-s3,d0 or PE Foam insulation	<b>E 240 C/U, EI 30 C/U</b>
40 mm diameter/1.5-14.2 mm wall*	1 off 50 x 1.8mm Bostik FP 340 Pipe Wrap, fitted central	13 -19 mm Elastomeric insulation minimum class B-s3,d0 or PE Foam insulation	<b>E 240 C/U, EI 60 C/U</b>
50 mm diameter/1.6-14.2 mm wall*			
60 mm diameter/1.7-14.2 mm wall*			
75 mm diameter/1.9-14.2 mm wall*			
90 mm diameter/2-14.2 mm wall*			
100 mm diameter/2.1-14.2 mm wall*			
115 mm diameter/2.3-14.2 mm wall*			
140 mm diameter/2.6-14.2 mm wall*			
165 mm diameter/2.8-14.2 mm wall*			

\* Typical pipe diameters shown, see below graph for intermediate sizes

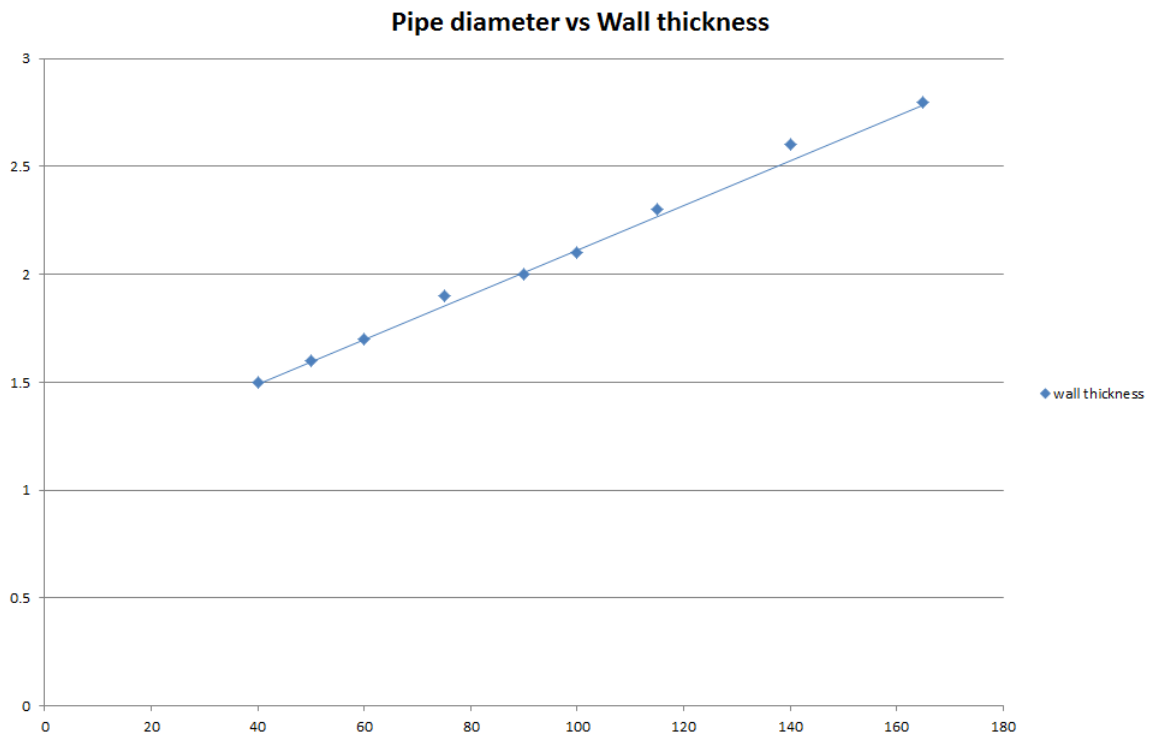

**A.1.1.2**

Services	Wrap	Insulation	Classification
Mild or stainless steel pipe	1 off 50 x 3.6mm Bostik FP 340 Pipe Wrap, fitted central	13-25 mm Elastomeric insulation minimum class B-s3,d0 or PE Foam insulation	<b>E 180 C/U, EI 60 C/U</b>
40 mm diameter/1.5-14.2 mm wall*			
50 mm diameter/1.8-14.2 mm wall*			
60 mm diameter/2-14.2 mm wall*			
75 mm diameter/2.3-14.2 mm wall*			
90 mm diameter/2.7-14.2 mm wall*			
100 mm diameter/2.9-14.2 mm wall*			
115 mm diameter/3.3-14.2 mm wall*			
140 mm diameter/3.9-14.2 mm wall*			
165 mm diameter/4.5-14.2 mm wall*			

\* Typical pipe diameters shown, see below graph for intermediate sizes

**Pipe diameter vs Wall thickness**

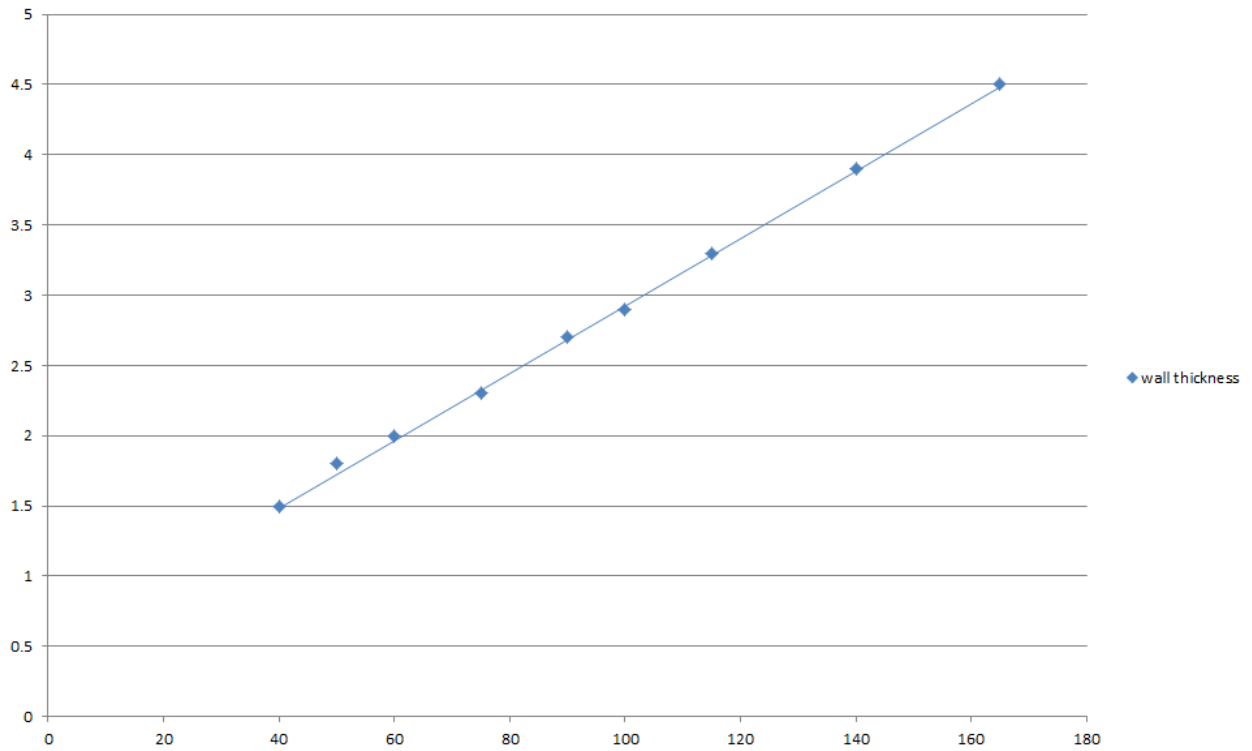

**A.1.2 Bostik FP 340 Pipe Wrap penetration seals, in 100 mm thick Bostik FP 370 Fireseal Mortar seals in rigid walls with plastic pipes**

**Penetration Seal:** plastic pipes fitted at any position within the aperture (min. separation 10 mm from seal edges), with 100 mm Bostik FP 370 Fireseal Mortar to either side of the wall. Bostik FP 340 Pipe Wraps are required to be centrally within the seal. Maximum seal size 2400 mm wide x 1200 mm high

Construction details:

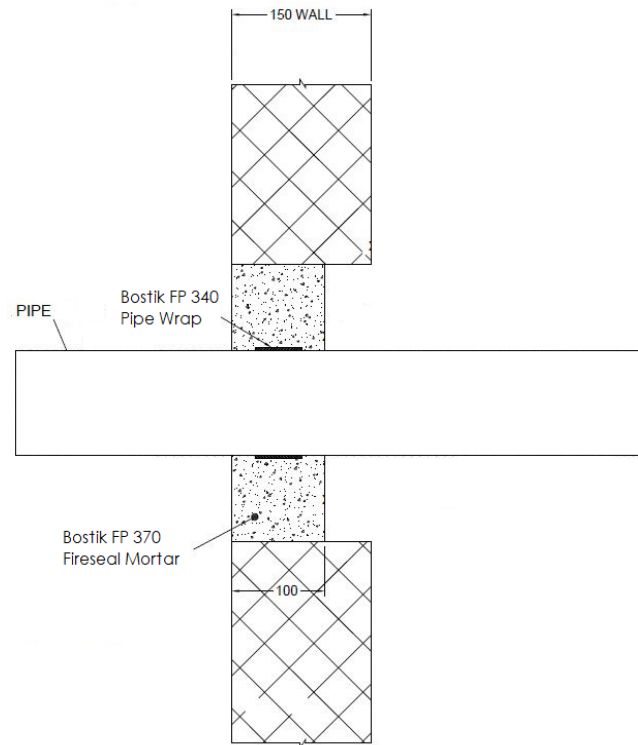

**A.1.2.1**

Services	Wrap	Insulation	Classification
PVC-U pipe according to EN 1329-1, EN 1452-1 and EN 1453-1 and PVC-C according to EN 1566-1			
315 mm diameter/9.2 mm wall	1 off 75 x 18 mm Bostik FP 340 Pipe Wrap, fitted central	None	EI 120 C/C

**A.2 Rigid floor constructions with a minimum thickness 150 mm**

**A.2.1 Bostik FP 340 Pipe Wrap penetration seals, in 100 mm thick Bostik FP 370 Fireseal Mortar seals in rigid floors, with insulated metal pipes**

**Penetration Seal:** CS (Continuous Sustained) insulated metallic pipes fitted at any position within the aperture (min. separation 25 mm from seal edges and 30 mm from other services), with 100 mm Bostik FP 370 Fireseal Mortar at any position within the floor. Bostik FP 340 Pipe Wraps are required to be fitted around combustible pipe insulation. Maximum seal size 1200 x 2400 mm.

Construction details:

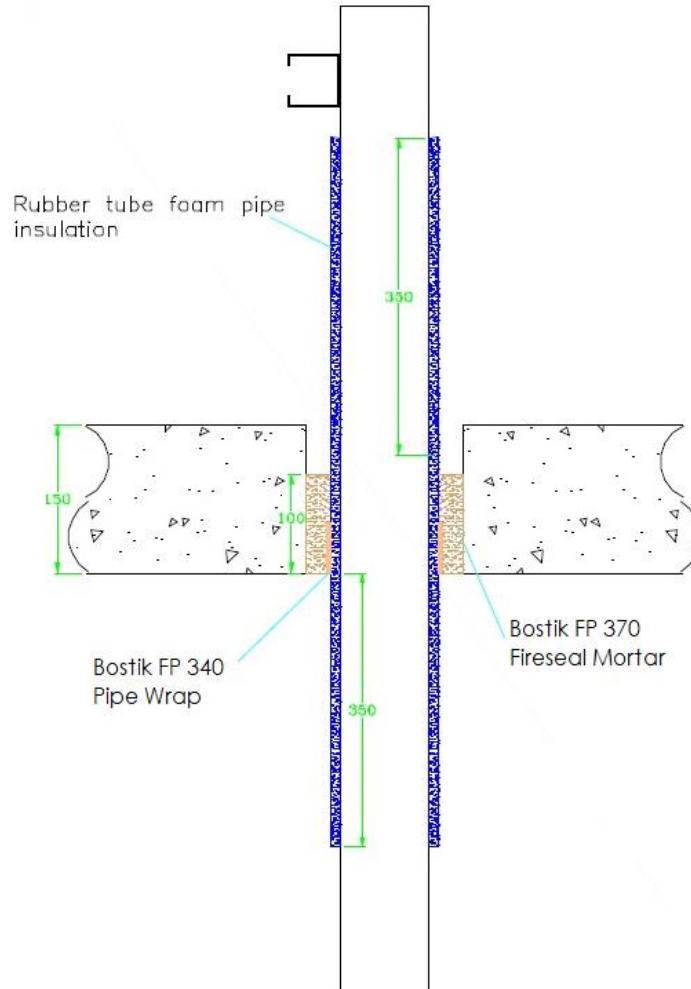

**A.2.1.1**

Services	Wrap	Insulation	Classification
Copper pipe			
12 mm diameter/1 mm wall	50 x 3.6 mm Bostik FP 340 Pipe Wrap fitted to the soffit	9 mm Elastomeric insulation minimum class B-s3,d0 or foil faced Phenolic Foam insulation	<b>EI 240 C/C</b>
12-54 mm diameter/1-1.2 mm wall		13-25 mm Elastomeric insulation minimum class B-s3,d0 or foil faced Phenolic Foam insulation	<b>E 240 C/C, EI 60 C/C</b>
<b>Geberit Mepla MLC (PE-Xb/Aluminium/PE-HD pipe)</b>			
16 mm diameter/2.25 mm wall	50 x 3.6 mm Bostik FP 340 Pipe Wrap fitted to the soffit	9 mm Elastomeric insulation minimum class B-s3,d0 or foil faced Phenolic Foam insulation	<b>EI 240 C/C</b>
16 mm diameter/2.25 mm wall		9-13 mm Elastomeric insulation minimum class B-s3,d0 or foil faced Phenolic Foam insulation	<b>E 240 C/C, EI 90 C/C</b>
20 mm diameter/2.5 mm wall			
26 mm diameter/3 mm wall			
32 mm diameter/3 mm wall			
40 mm diameter/3.5 mm wall			
50 mm diameter/4 mm wall			
63 mm diameter/4.5 mm wall		13-25 mm Elastomeric insulation minimum class B-s3,d0 or foil faced Phenolic Foam insulation	<b>E 180 C/C, EI 90 C/C</b>
75 mm diameter/4.7 mm wall			
16 mm diameter/2.25 mm wall			
20 mm diameter/2.5 mm wall			
26 mm diameter/3 mm wall			
32 mm diameter/3 mm wall			
40 mm diameter/3.5 mm wall			
50 mm diameter/4 mm wall			
63 mm diameter/4.5 mm wall			
75 mm diameter/4.7 mm wall			

## A.2.2 Bostik FP 340 Pipe Wrap penetration seals, in 100 mm thick Bostik FP 370 Fireseal Mortar seals in rigid floors, with insulated metal pipes

**Penetration Seal:** CS (Continuous Sustained) insulated metallic pipes fitted at any position within the aperture (min. separation 30 mm from seal edges and 30 mm from other services), with 100 mm Bostik FP 370 Fireseal Mortar to the top surface of the floor. Bostik FP 340 Pipe Wraps are required to be fitted around combustible pipe insulation. Maximum seal size 2400 mm x 1200 mm.

Construction details:

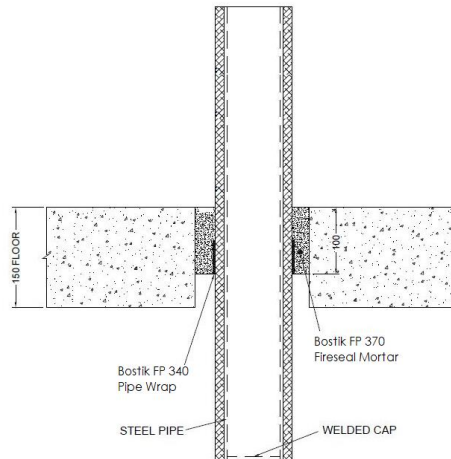

### A.2.2.1

Services	Wrap	Insulation	Classification
Mild or stainless steel pipe			
40 mm diameter/-14.2 mm wall		13 mm Elastomeric insulation minimum class B- s3,d0 or foil faced Phenolic Foam insulation	<b>EI 180 C/U</b>
40 mm diameter/1.5-14.2 mm wall*	1 off 50 x 1.8 mm Bostik FP 340 Pipe Wrap, fitted at soffit	13 -19 mm Elastomeric insulation minimum class B- s3,d0 or foil faced Phenolic Foam insulation	<b>E 180 C/U, EI 120 C/U</b>
50 mm diameter/1.6-14.2 mm wall*			
60 mm diameter/1.7-14.2 mm wall*			
75 mm diameter/1.9-14.2 mm wall*			
90 mm diameter/2-14.2 mm wall*			
100 mm diameter/2.1-14.2 mm wall*			
115 mm diameter/2.3-14.2 mm wall*			
140 mm diameter/2.6-14.2 mm wall*			
165 mm diameter/2.8-14.2 mm wall*			

\* Typical pipe diameters shown, see below graph for intermediate sizes

Pipe diameter vs Wall thickness

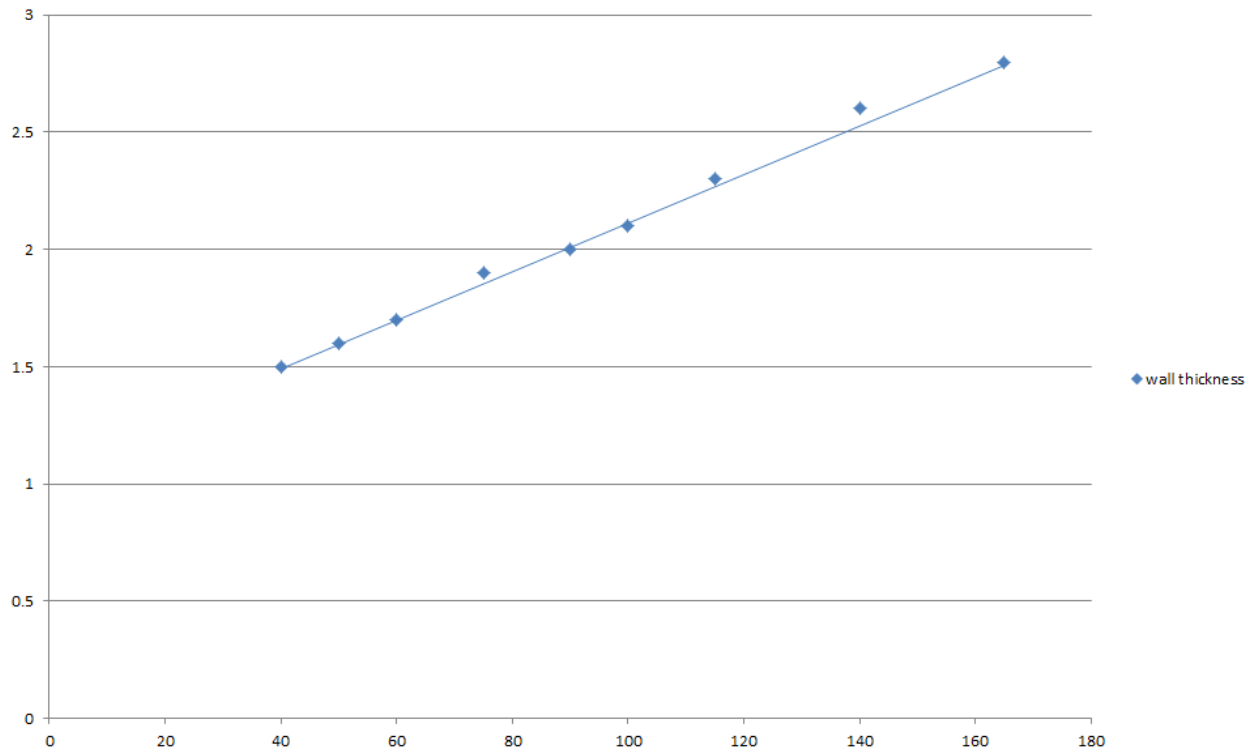

### A.2.3 Bostik FP 340 Pipe Wrap penetration seal for insulated metal pipes, in Bostik FP 370 Fireseal Mortar Seal, in rigid floors

**Penetration Seal:** CS (Continuous Sustained) insulated metallic pipes sealed with Bostik FP 340 Pipe Wrap, fitted at any position within the aperture, with 100 mm Bostik FP 370 Fireseal Mortar Seal. Minimum separation between penetration seals and seal edges of 30 mm (Configuration 1 & 2).

Construction details:

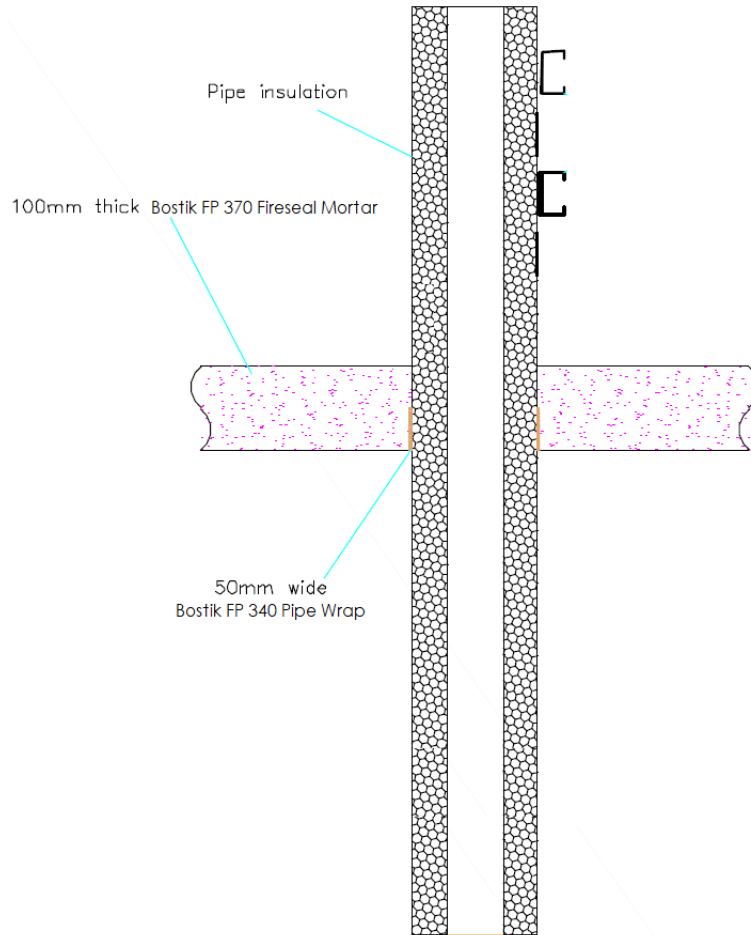

**Configuration 1**

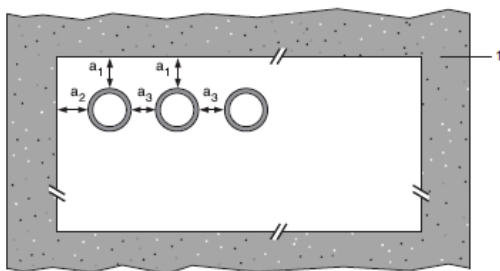

**Configuration 2**

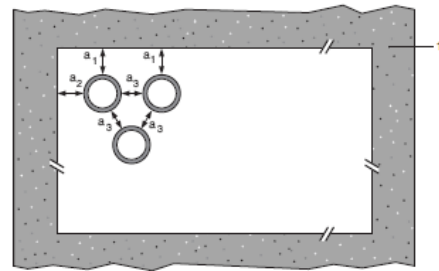

**Key**

- 1 Supporting construction
- a1 Pipe / top edge of seal separation
- a2 Pipe / side edge of seal separation
- a3 Pipe / pipe separation



**A.2.3.1**

Mild or stainless steel pipe	Insulation	Bostik FP 340 Pipe Wrap	Classification																																				
40 mm diameter/1-14.2 mm wall	25 mm thick Elastomeric insulation minimum class B-s3,d0 or foil faced Phenolic Foam insulation	50 x 3.6 mm (2 x 1.8 layer)	<b>EI 240 C/U</b>																																				
40 mm diameter/1-14.2 mm wall*	25mm thick Elastomeric insulation minimum class B-s3,d0 or foil faced Phenolic Foam insulation			<b>E 240 C/U EI 120 C/U</b>																																			
50 mm diameter/1.2-14.2 mm wall*																																							
60 mm diameter/1.4-14.2 mm wall*																																							
75 mm diameter/1.6-14.2 mm wall*																																							
90 mm diameter/1.9-14.2 mm wall*																																							
100 mm diameter/2.1-14.2 mm wall*																																							
115 mm diameter/2.4-14.2 mm wall*																																							
140 mm diameter/2.9-14.2 mm wall*																																							
165 mm diameter/ 3.4-14.2 mm wall*																																							
180 mm diameter/ 3.6-14.2 mm wall*																																							
200 mm diameter/ 4.0-14.2 mm wall*																																							
219 mm diameter/ 4.3-14.2 mm wall*																																							
250 mm diameter/ 5.0-14.2 mm wall*																																							
300 mm diameter/ 5.9-14.2 mm wall*																																							
324 mm diameter/ 6.35-14.2 mm wall*																																							
40 mm diameter/1-14.2 mm wall*					25-50mm thick Elastomeric insulation minimum class B-s3,d0 or foil faced Phenolic Foam insulation	50 x 5.4 mm (3 x 1.8 layer)	<b>EI 120 C/U</b>																																
50 mm diameter/1.2-14.2 mm wall*																																							
60 mm diameter/1.4-14.2 mm wall*																																							
75 mm diameter/1.6-14.2 mm wall*																																							
90 mm diameter/1.9-14.2 mm wall*																																							
100 mm diameter/2.1-14.2 mm wall*																																							
115 mm diameter/2.4-14.2 mm wall*																																							
140 mm diameter/2.9-14.2 mm wall*																																							
165 mm diameter/ 3.4-14.2 mm wall*																																							
180 mm diameter/ 3.6-14.2 mm wall*																																							
200 mm diameter/ 4.0-14.2 mm wall*																																							
219 mm diameter/ 4.3-14.2 mm wall*																																							
250 mm diameter/ 5.0-14.2 mm wall*																																							
300 mm diameter/ 5.9-14.2 mm wall*																																							
324 mm diameter/ 6.35-14.2 mm wall*																																							

Pipe Diameter vs wall thickness

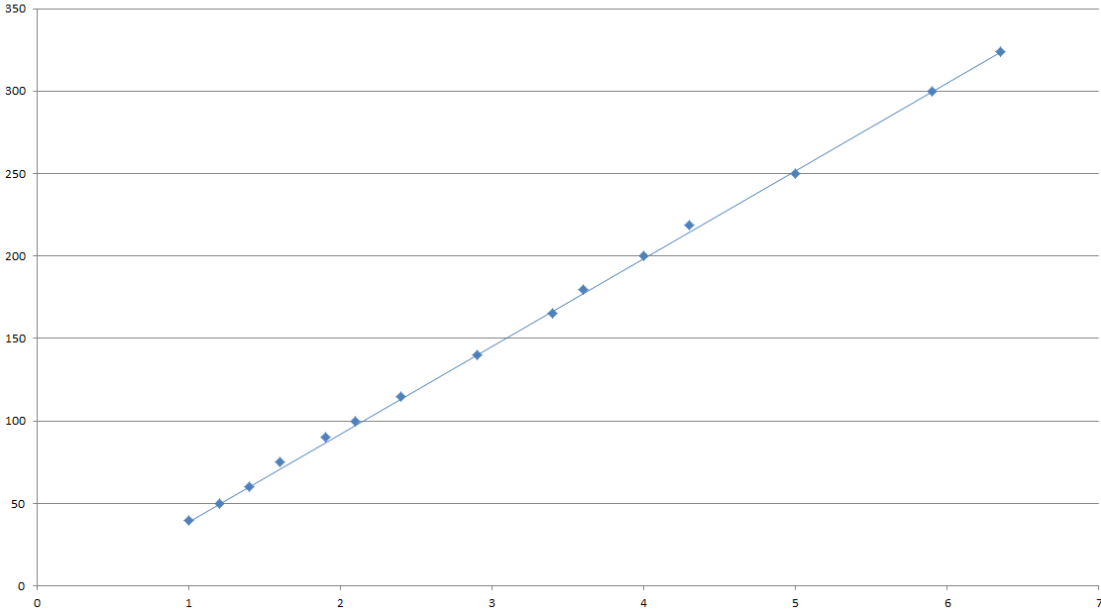

#### A.2.4 Bostik FP 340 Pipe Wrap penetration seals, in 100 mm deep Bostik FP 370 Fireseal Mortar seals in rigid floors, with plastic pipes

**Penetration Seal:** Plastic pipes fitted at any position within the aperture, with 100 mm Bostik FP 370 Fireseal Mortar to the either surface of the floor or anywhere between. Bostik FP 340 Pipe Wraps are required to be fitted to the bottom of the seal, as indicated below. Minimum separation between penetration seals and seal edges of 30 mm (Configuration 1 & 2).

Construction details:

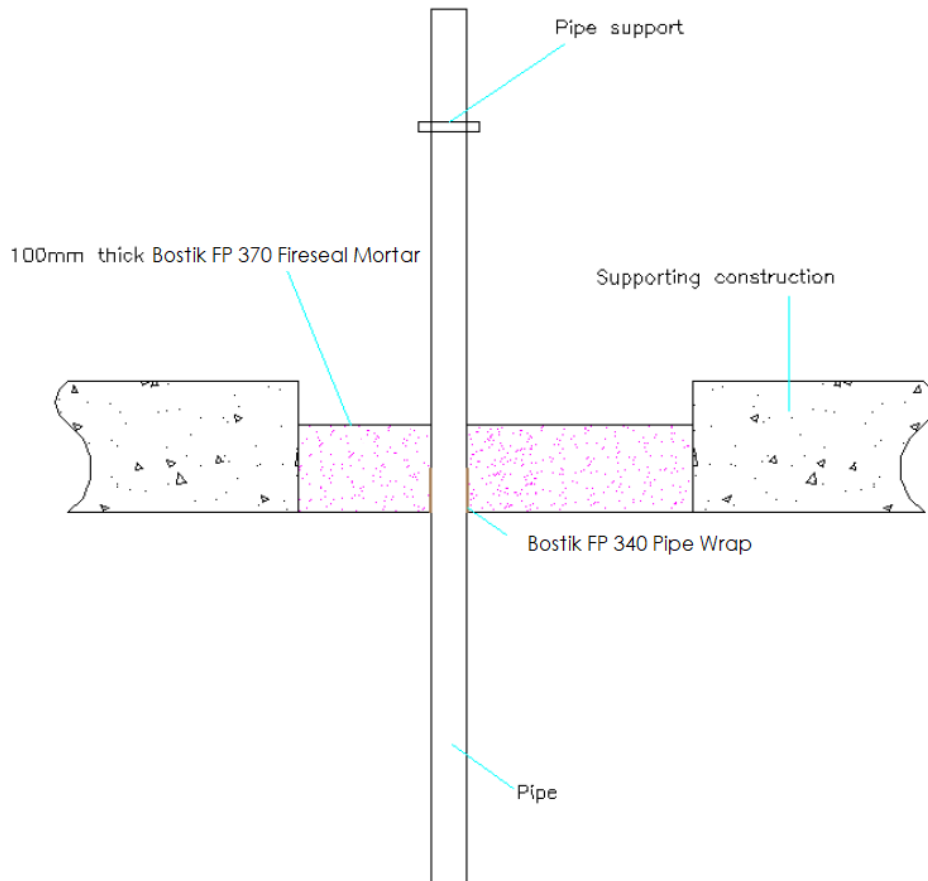

### A.2.4.1

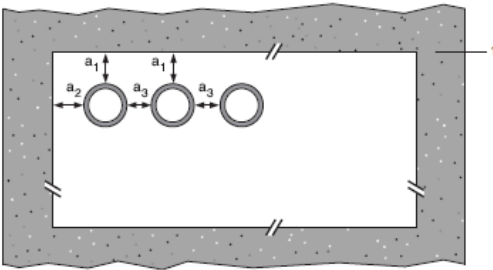
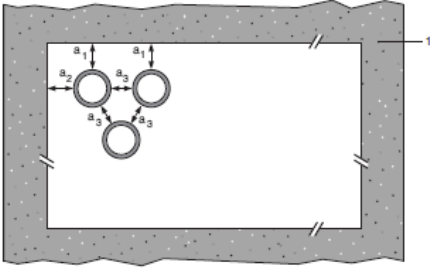
Services	Wrap	Maximum aperture	Classification
<b>PVC-U pipe according to EN 1329-1, EN 1452-1 and EN 1453-1, PVC-C according to EN 1566-1</b>			
Up to 40 mm diameter / 1.8-3.7 mm wall	50 x 1.8 mm	2400 x 1200 mm	<b>E 180 U/U, EI 120 U/U</b>
Up to 110 mm diameter / 3.0-6.6 mm wall	50 x 3.6 mm		<b>EI 240 U/C</b>
Up to 125 mm diameter / 3.5-7.4 mm wall	50 x 7.2 mm		<b>EI 120 U/C</b>
Up to 160 mm diameter / 4.5 mm wall	50 x 10.8 mm		<b>EI 240 C/C</b>
Up to 160 mm diameter / 4.5-9.5 mm wall	50 x 10.8 mm		<b>EI 90 C/C</b>
Up to 110 mm diameter / 2.7-6.6 mm wall, containing up to 90mm $\varnothing$ bundle of up to 14 mm $\varnothing$ telecom cables	50 x 3.6 mm		<b>EI 120 U/C</b>
<b>PP pipe according to EN 1451-1</b>			
Up to 40 mm diameter / 1.8-4.4 mm wall	None	2400 x 1200 mm	<b>EI 120 U/C</b>
Up to 40 mm diameter / 1.8-5.5 mm wall	50 x 1.8 mm		<b>EI 120 U/U</b>
Up to 50 mm diameter / 2.5-5.5 mm wall	50 x 3.6 mm		<b>EI 240 C/C</b>
Up to 75 mm diameter / 3.5-5.5 mm wall	50 x 3.6 mm		<b>EI 240 C/C</b>
Up to 110 mm diameter / 2.7-6.3 mm wall	50 x 3.6 mm		<b>EI 240 U/C</b>
Up to 125 mm diameter / 3.4-11.4 mm wall	50 x 7.2 mm		<b>EI 240 U/C</b>
Up to 160 mm diameter / 4.9-14.6 mm wall	50 x 10.8 mm		<b>EI 240 U/C</b>
Up to 110 mm diameter / 3.4-6.3 mm wall, containing up to 90mm $\varnothing$ bundle of up to 14 mm $\varnothing$ telecom cables	50 x 3.6 mm		<b>EI 60 U/C</b>
<b>PE pipe according to EN 1519-1, EN 12201-2 and EN 12666-1, ABS according to EN 1455-1 and pipes made from SAN+PVC according to EN 1565-1</b>			
Up to 40 mm diameter / 2.0-4.4 mm wall	None	2400 x 1200 mm	<b>EI 120 U/C</b>
Up to 40 mm diameter / 2.4-3.7 mm wall	50 x 1.8 mm		<b>EI 240 U/U</b>
Up to 110 mm diameter / 3.4-10.0 mm wall	50 x 3.6 mm		<b>EI 120 U/C</b>
Up to 125 mm diameter / 3.9-11.4 mm wall	50 x 7.2 mm		<b>EI 240 U/C</b>
Up to 160 mm diameter / 4.9-14.6 mm wall	50 x 10.8 mm		<b>EI 120 U/C</b>
Up to 250 mm diameter / 7.8 mm wall	75 x 12.6 mm		<b>EI 180 C/C</b>
Up to 110 mm diameter / 2.7-10.0 mm wall, containing up to 90mm $\varnothing$ bundle of up to 14 mm $\varnothing$ telecom cables	50 x 3.6 mm		<b>E 120 U/C, EI 60 U/C</b>
<b>Configuration 1</b>		<b>Configuration 2</b>	
			
<b>Key</b>			
1 Supporting construction			
a1 Pipe / top edge of seal separation			
a2 Pipe / side edge of seal separation			
a3 Pipe / pipe separation			

PVC-U pipes U/C with Bostik FP 340 Pipe Wrap - EI 120 U/C

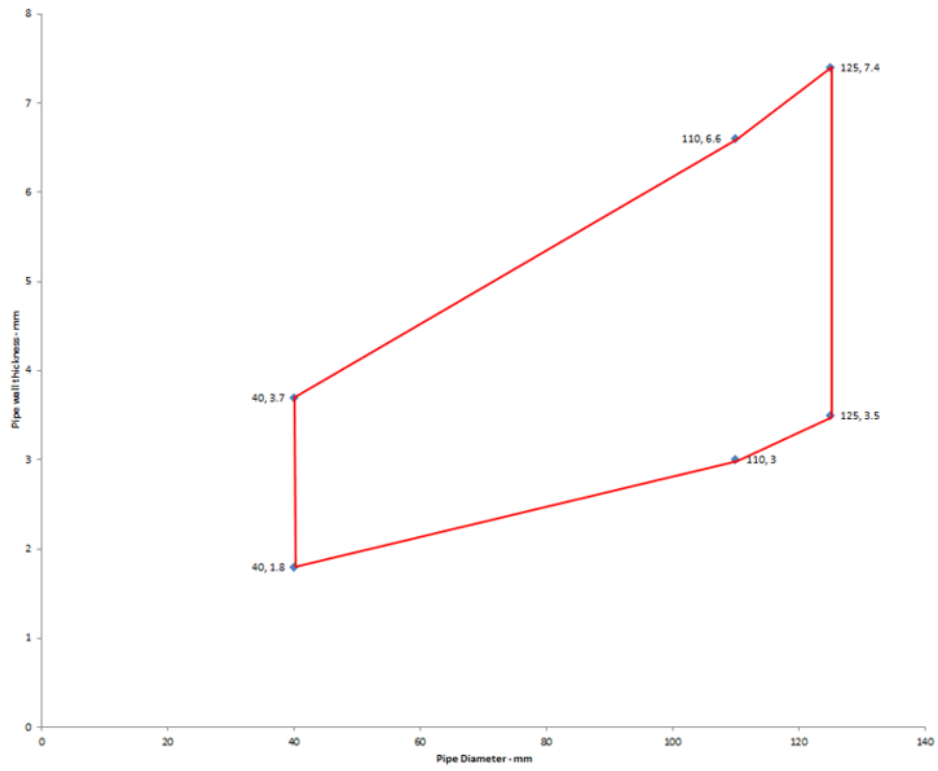

PE pipes U/C with Bostik FP 340 Pipe Wrap - EI 120 U/C

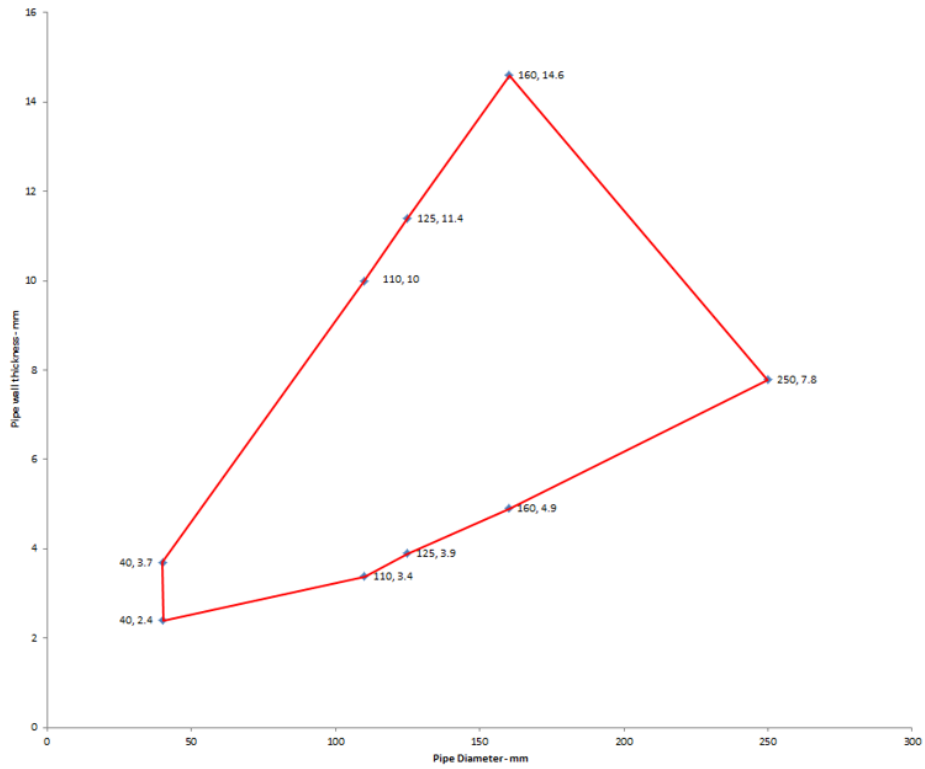

PP pipes U/C with Boslik FP 340 Pipe Wrap - EI 120 U/C

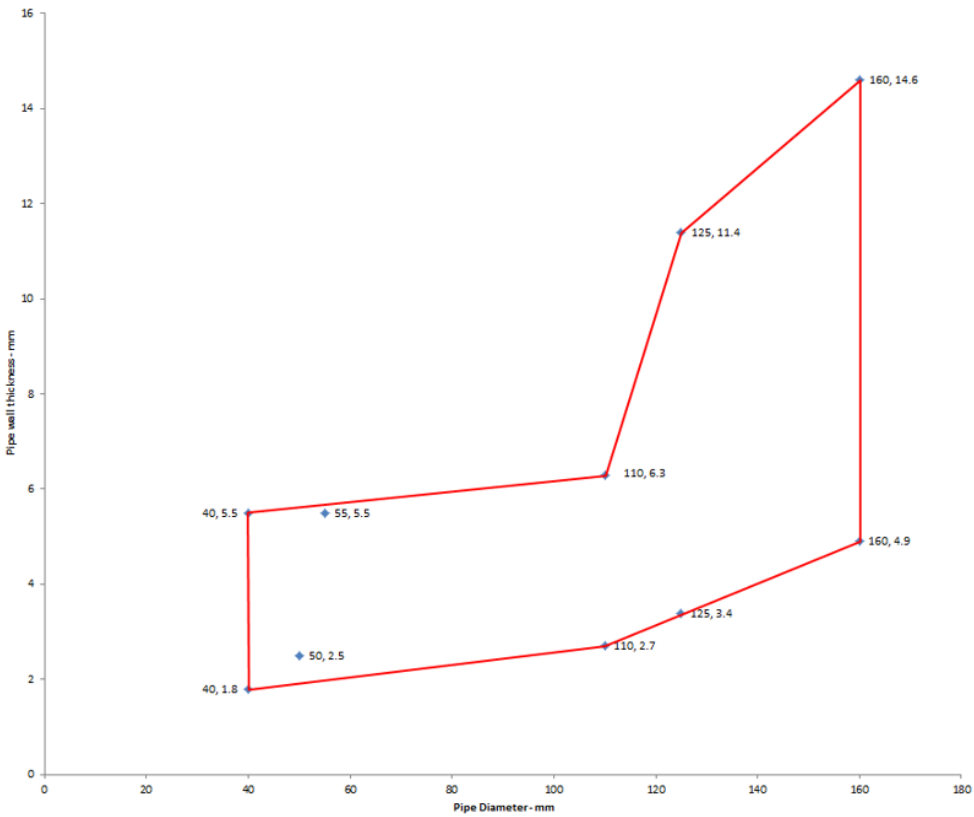

**A.2.5 Bostik FP 340 Pipe Wrap penetration seals, in 100 mm thick Bostik FP 370 Fireseal Mortar seals in rigid floors, with plastic pipes**

**Penetration Seal:** Plastic pipes fitted at any position within the aperture (min. separation 30 mm from seal edges and from other services), with 100 mm Bostik FP 370 Fireseal Mortar to the bottom surface of the floor. Bostik FP 340 Pipe Wraps are required to be fitted to the bottom of the seal, as indicated below. Maximum seal size 2400 mm x 1200 mm.

Construction details:

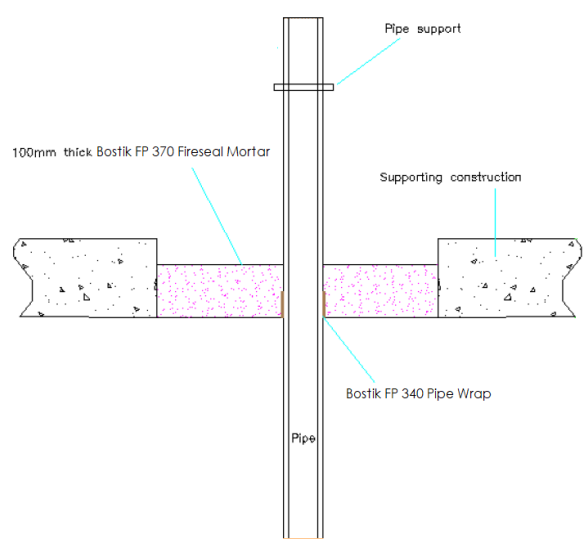
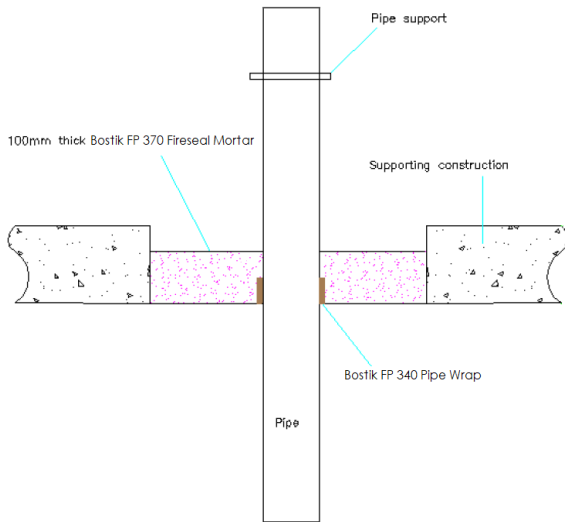

**Configuration 1**

**Configuration 2**

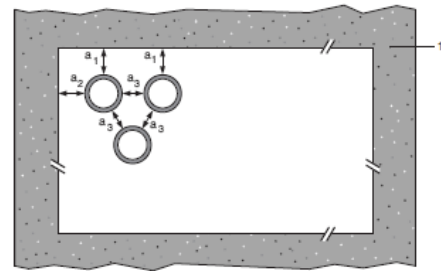
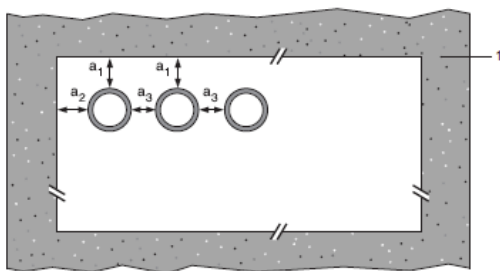

**Key**

- 1 Supporting construction
- a1 Pipe / top edge of seal separation
- a2 Pipe / side edge of seal separation
- a3 Pipe / pipe separation

### A.2.5.1

Services	Wrap	Permitted configuration for seal separation	Classification
PVC-U pipe according to EN 1329-1, EN 1452-1 and EN 1453-1, PVC-C according to EN 1566-1			
160 mm diameter / 9.5 mm wall	50 x 10.8 mm (6 x 1.8 layers)	1 & 2	EI 90 U/C
Uponor Wirsbo PEX pipe in pipe system according to ISO 15875			
Maximum 54 mm diameter/0.4 mm wall thickness (outer pipe), 28 mm diameter/4.0 mm wall thickness (inner pipe)	50 x 3.6 mm (2 x 1.8 layers)	1 & 2	EI 120 C/C
Rehau Raupiano Plus PP-DD according to DIN 4102			
40-50 mm diameter/1.8-2.7 mm wall thickness*	50 x 3.6 mm (2 x 1.8 layers)	1 & 2	EI 120 U/U
75-110 mm diameter/2.7 mm wall thickness*	50 x 3.6 mm (2 x 1.8 layers)	1 & 2	EI 120 U/C
125 mm diameter/3.1 mm wall thickness	50 x 7.2 mm (4 x 1.8 layers)	1 & 2	E 240 U/C, EI 120 U/C
160 mm diameter/3.9 mm wall thickness	50 x 10.8 mm (6 x 1.8 layers)	1 & 2	EI 120 U/C
Polo-Kal NG Poloplast PP-MV according to DIN 4102			
32-110 mm diameter/3.4 mm wall thickness	50 x 3.6 mm (2 x 1.8 layers)	1 & 2	EI 180 U/C
125 mm diameter/3.9 mm wall thickness	50 x 7.2 mm (4 x 1.8 layers)	1 & 2	EI 240 U/C
160 mm diameter/4.3 mm wall thickness	50 x 10.8 mm (6 x 1.8 layers)	1 & 2	EI 240 U/C
Aquatherm Green SDR9 MF PP-RP according to ISO 21003			
32 mm diameter/3.6 mm wall thickness	50 x 1.8 mm (1 x 1.8 layer)	1 & 2	EI 240 C/C
40-50 mm diameter/5.6-12.3 mm wall thickness*	50 x 3.6 mm (2 x 1.8 layers)	1 & 2	EI 240 C/C
63-110 mm diameter/12.3 mm wall thickness*	50 x 3.6 mm (2 x 1.8 layers)	1 & 2	EI 240 C/C
Wavin SiTech + PP-M B according to EN 13501-1			
32-50 mm diameter/1.8-3.4 mm wall thickness*	50 x 3.6 mm (2 x 1.8 layers)	1 & 2	EI 120 U/U
75-110 mm diameter/3.4 mm wall thickness*	50 x 3.6 mm (2 x 1.8 layers)	1 & 2	EI 120 U/C
Gilbert Silent PP according to DIN 4102			
32-50 mm diameter/1.8-3.4 mm wall thickness*	50 x 3.6 mm (2 x 1.8 layers)	1 & 2	EI 120 U/U
75-110 mm diameter/3.4 mm wall thickness*	50 x 3.6 mm (2 x 1.8 layers)	1 & 2	EI 120 U/C

\* Typical pipe diameters shown, see below graph for intermediate sizes



### Rehau Raupiano Plus -EI 120 U/U

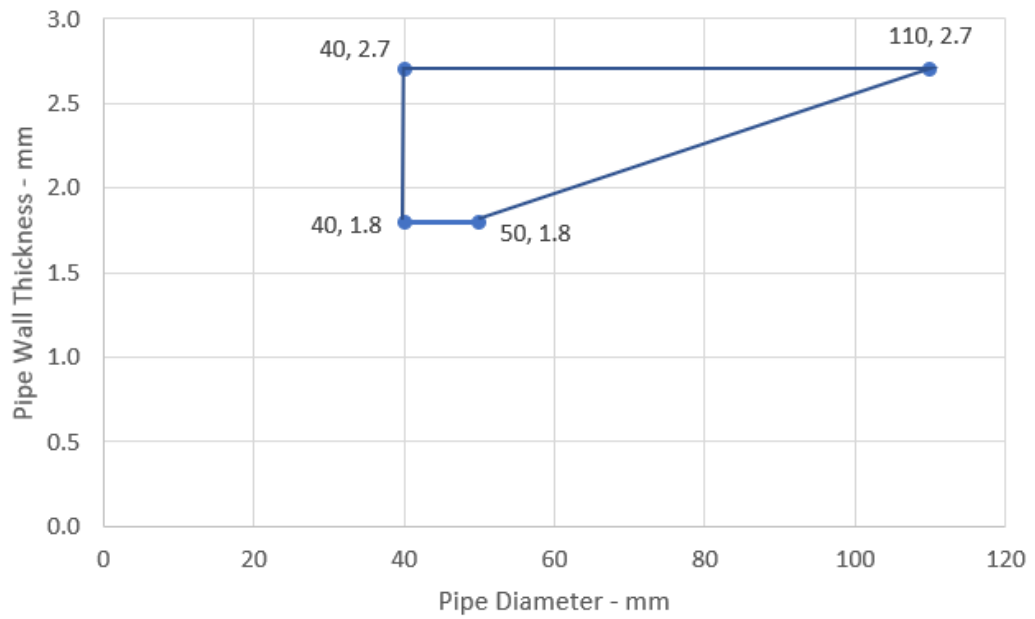

### Aquatherm Green - EI 240 C/C

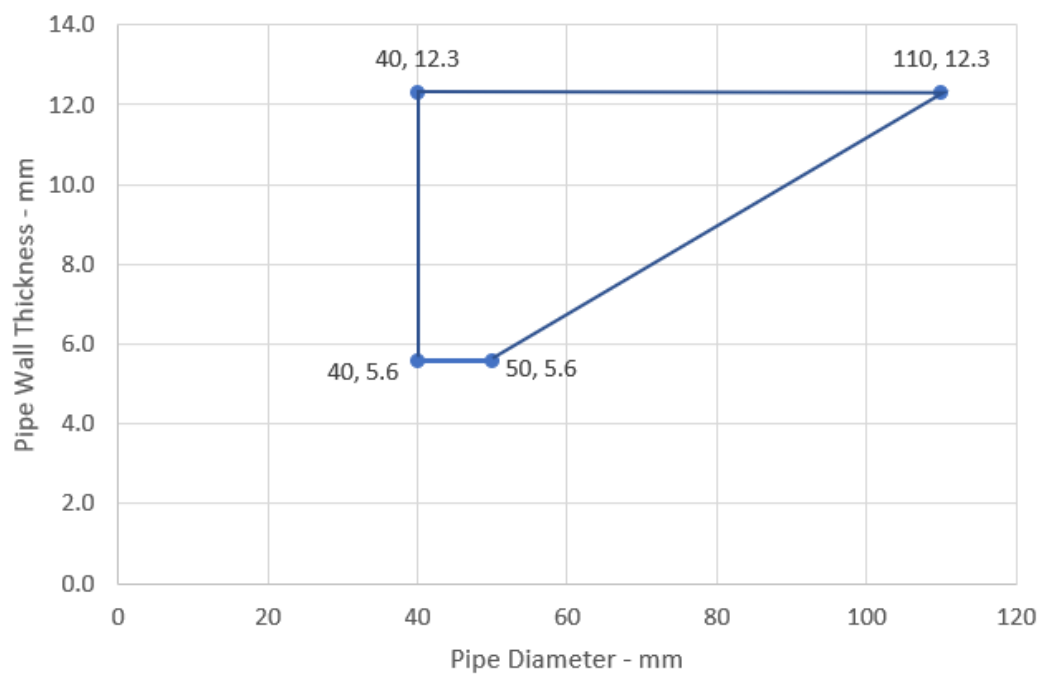

### Wavin SiTech Pipes - EI 120 U/C

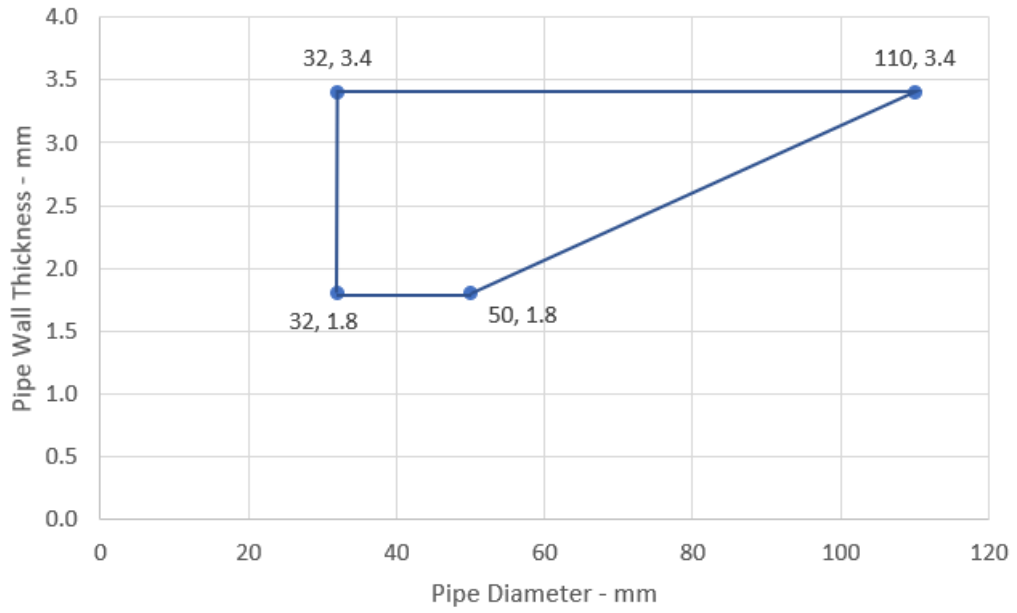

### Gilbert Silent PP - EI 120 U/C

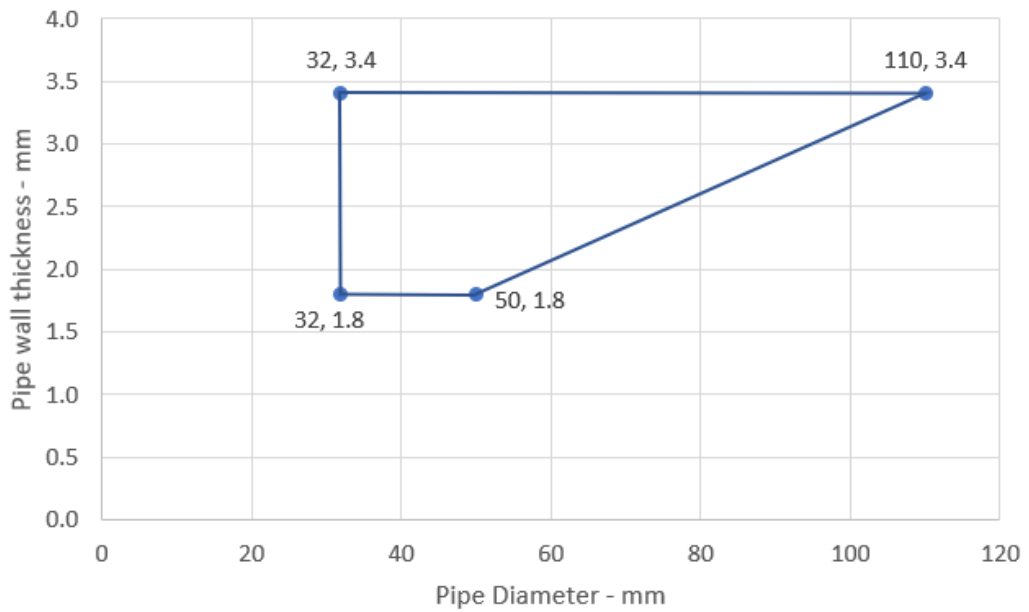

## A.2.6 Bostik FP 340 Pipe Wrap penetration seals, in Bostik FP 370 Fireseal Mortar seals in rigid floors, with plastic pipes

**Penetration Seal:** Plastic pipes fitted at any position within the aperture (min. separation 30 mm from seal edges and from other services), with Bostik FP 370 Fireseal Mortar to the bottom surface of the floor. Bostik FP 340 Pipe Wraps are required to be fitted to the bottom of the seal, as indicated below. Maximum seal size 2400 mm x 1200 mm.

Construction details:

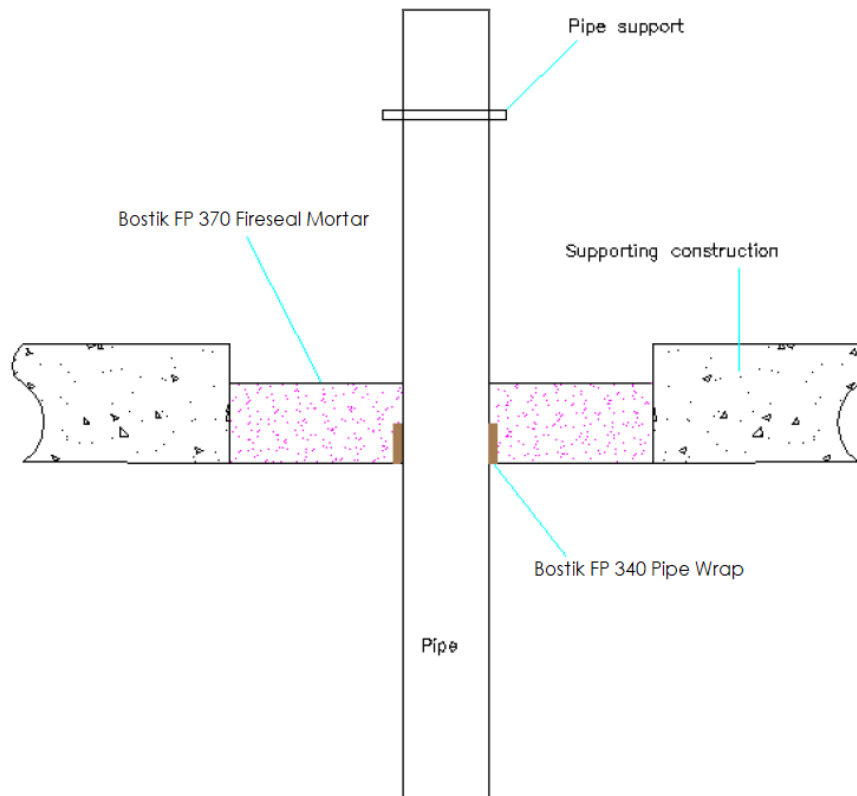

**Configuration 1**

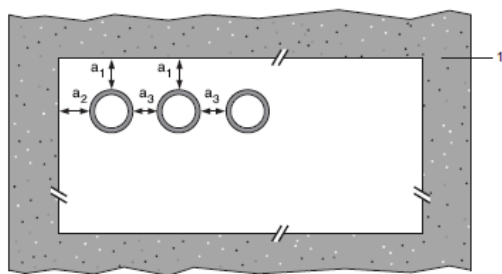

**Configuration 2**

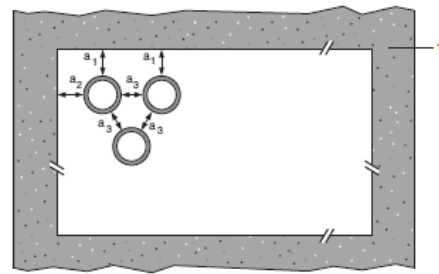

**Key**

- 1 Supporting construction
- a1 Pipe / top edge of seal separation
- a2 Pipe / side edge of seal separation
- a3 Pipe / pipe separation

### A.2.6.1

Services	Wrap	Permitted configuration for seal separation	Mortar depth	Classification
<b>PVC-U pipe according to EN 1329-1, EN 1452-1 and EN 1453-1, PVC-C according to EN 1566-1</b>				
Diameter 41 mm, wall thickness 1.8-3.7 mm to diameter 125 mm, wall thickness 4.8-7.4 mm*	50 x 7.2 mm (4 x 1.8 layers)	1 & 2	150 mm	EI 60 U/U
125 mm diameter / 7.4 mm wall	50 x 7.2 mm (4 x 1.8 layers)	1 & 2	150 mm	EI 120 U/U
Diameter 126 mm, wall thickness 4.8-7.4 mm to diameter 160 mm, wall thickness 9.5 mm*	75 x 10.8 mm (6 x 1.8 layers)	1	150 mm	E 120 U/U, EI 30 U/U
160 mm diameter / 9.5 mm wall	75 x 7.2 mm (4 x 1.8 layers)	1	150 mm	E 120 U/U, EI 30 U/U
160 mm diameter / 4.5-9.5 mm wall thickness	50 x 10.8 mm (6 x 1.8 layers)	1 & 2	120 mm	EI 120 U/C, EI 120 C/C
315 mm diameter / 7.7 mm wall thickness	75 x 18 mm (10 x 1.8 layers)	1	120 mm	EI 120 C/C
Diameter 161 mm, wall thickness 4.5-9.5 mm to diameter 315 mm, wall thickness 7.7-12.1 mm*	75 x 18 mm (10 x 1.8 layers)	1	120 mm	EI 90 C/C
315 mm diameter / 12.1 mm wall thickness	75 x 18 mm (10 x 1.8 layers)	1	120 mm	EI 90 C/C
<b>PP pipe according to EN 1451-1</b>				
Diameter 41 mm, wall thickness 1.8-5.5 mm to diameter 160 mm, wall thickness 4.9-14.6 mm*	75 x 10.8 mm (6 x 1.8 layers)	1 & 2	150 mm	EI 120 U/C
160 mm diameter / 14.6 mm wall	75 x 7.2 mm (4 x 1.8 layers)	1 & 2	150 mm	EI 240 U/U
Diameter 161 mm, wall thickness 4.9-14.6 mm to diameter 200 mm, wall thickness 4.9-18.2 mm*	75 x 10.8 mm (6 x 1.8 layers)	1 & 2	120 mm	EI 240 C/C
Diameter 201 mm, wall thickness 4.9-18.2 mm to diameter 315 mm, wall thickness 7.7-28.6 mm*	75 x 18 mm (10 x 1.8 layers)	N/A	150 mm	EI 60 C/C
315 mm diameter / 7.7 mm wall	75 x 18 mm (10 x 1.8 layers)	N/A	150 mm	EI 180 C/C
315 mm diameter / 7.7-28.6 mm wall	75 x 18 mm (10 x 1.8 layers)	1	150 mm	EI 60 C/C

Services	Wrap	Permitted configuration for seal separation	Mortar depth	Classification
<b>PE pipe according to EN 1519-1, EN 12201-2 and EN 12666-1, ABS according to EN 1455-1 and pipes made from SAN+PVC according to EN 1565-1</b>				
Diameter 126 mm, wall thickness 3.9-11.4 mm to diameter 160 mm, wall thickness 14.6*	75 x 18 mm (10 x 1.8 layers)	N/A	150 mm	<b>E 240 U/U, EI 120 U/U</b>
160 mm diameter / 14.6 mm wall	75 x 7.2 mm (4 x 1.8 layers)	1 & 2	150 mm	<b>E 240 U/U, EI 120 U/U</b>
Diameter 161 mm, wall thickness 4.9-14.6 mm to diameter 315 mm, wall thickness 9.7-18.7 mm*	75 x 18 mm (10 x 1.8 layers)	N/A	150 mm	<b>EI 60 C/C</b>

\* Typical pipe diameters shown, see below graph for intermediate sizes

### PVC-U Pipes 41-125 mm Diameter - EI 60 U/U

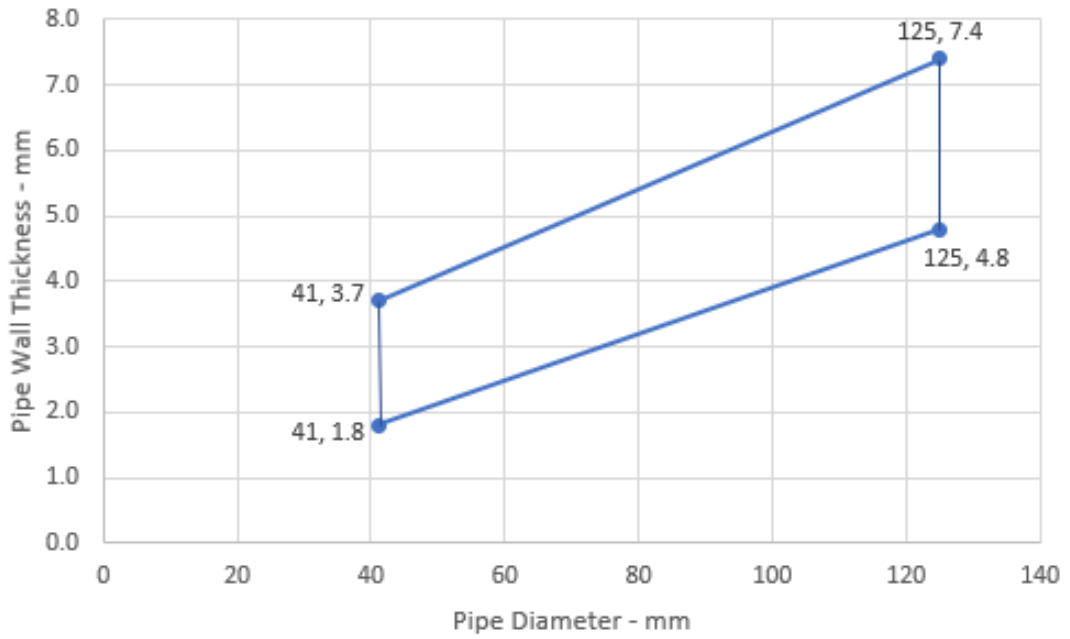

### PVC-U Pipes 126-160 mm Diameter - E 120 U/U, EI 30 U/U

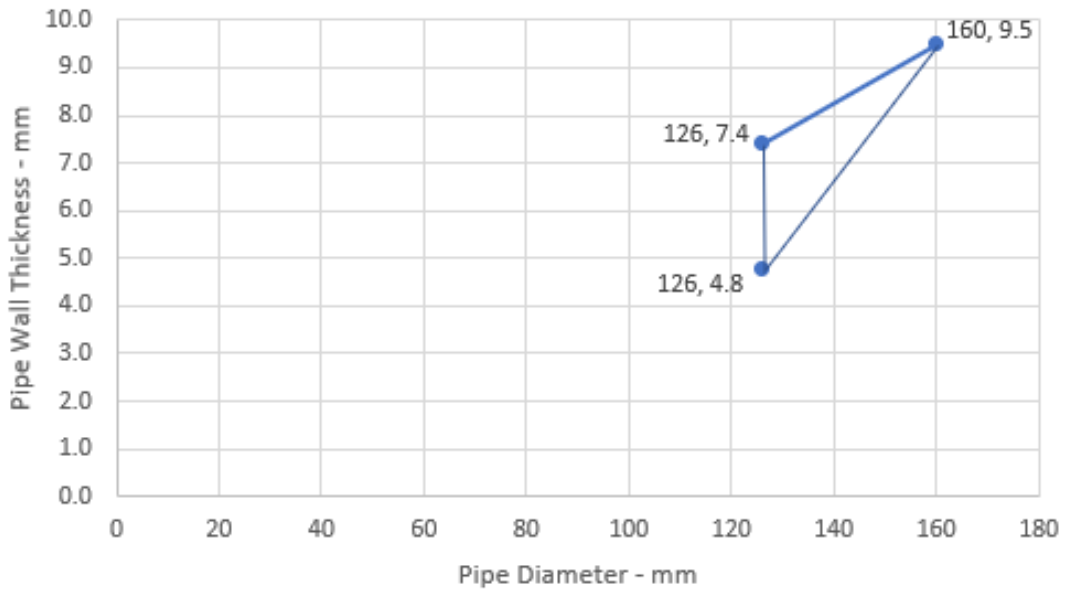

### PVC-U Pipes - EI 90 C/C

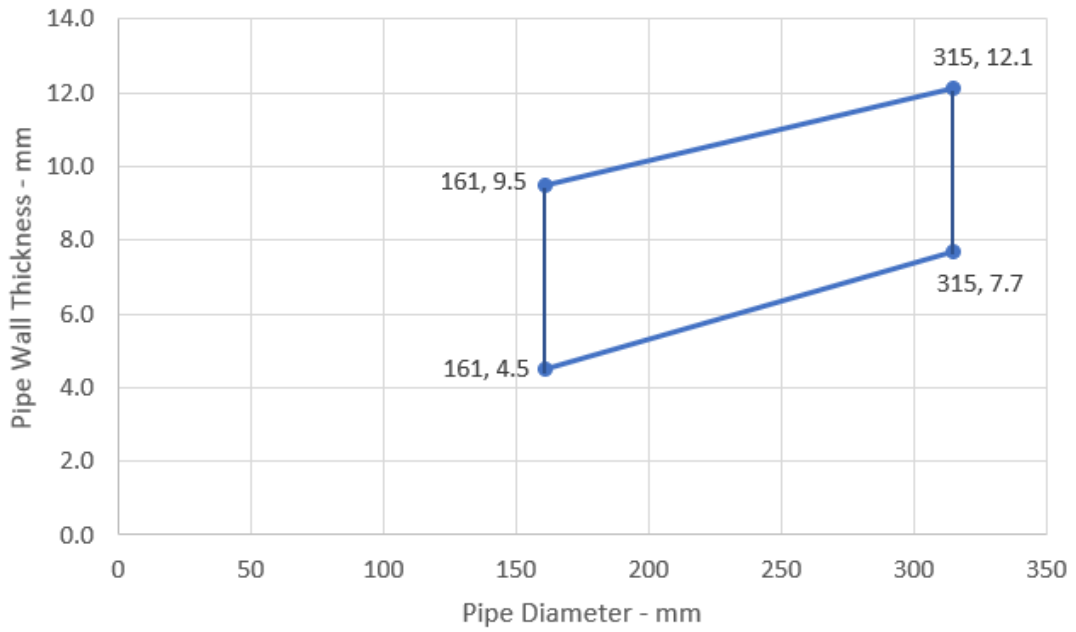

### PP Pipes 41-160 mm Diameter - EI 120 U/C

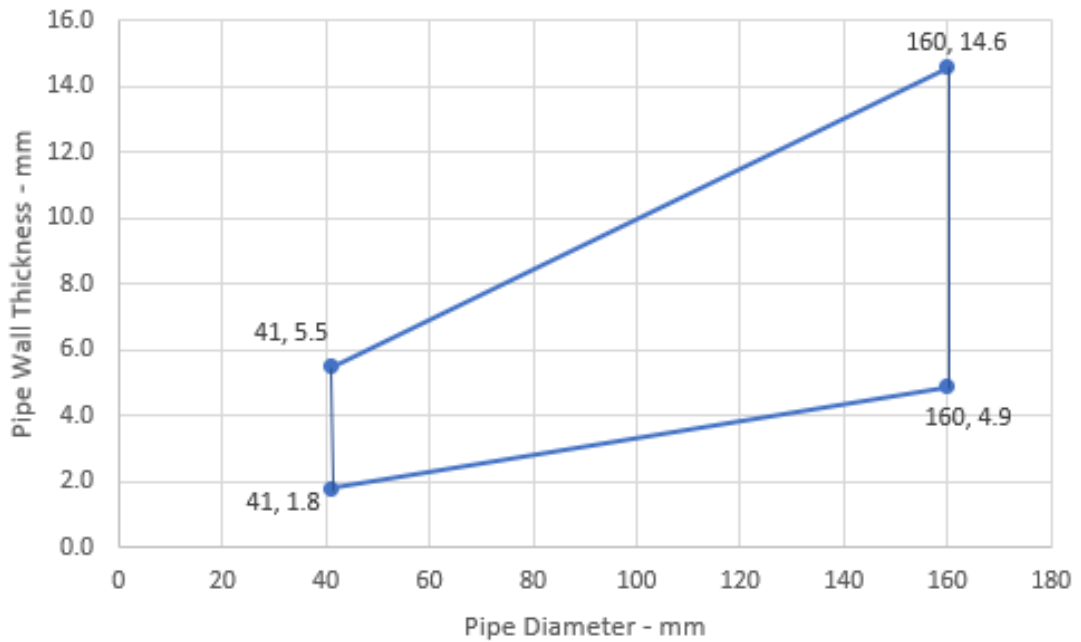

### PP Pipes - EI 240 C/C

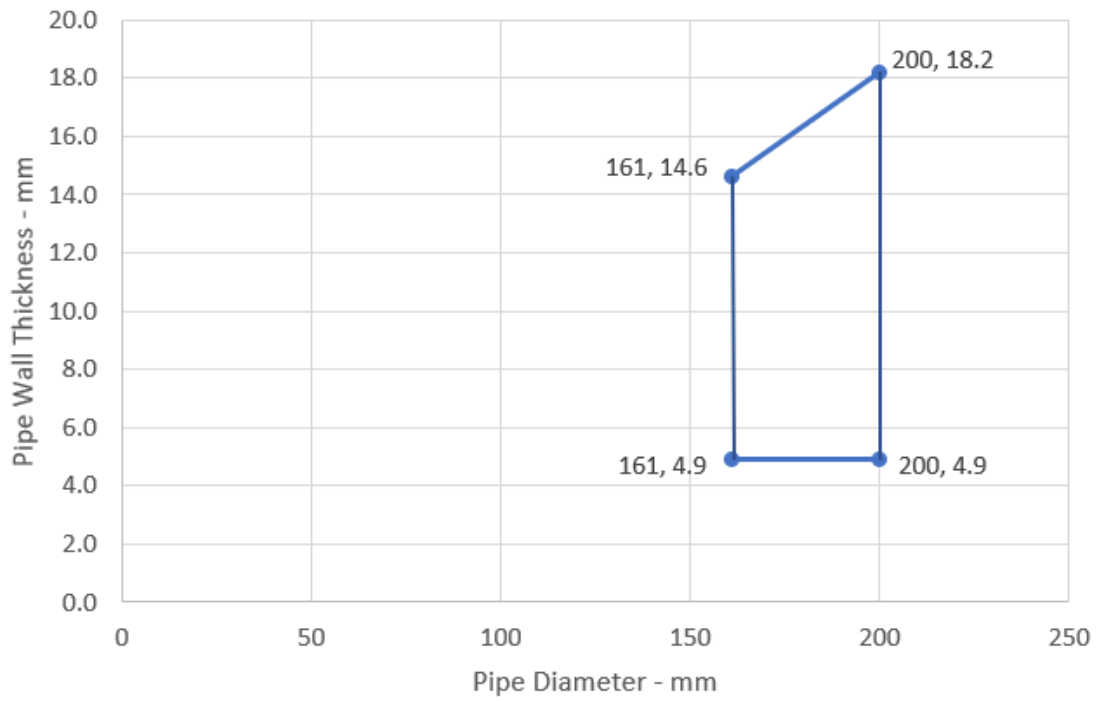

### PP Pipes - EI 60 C/C

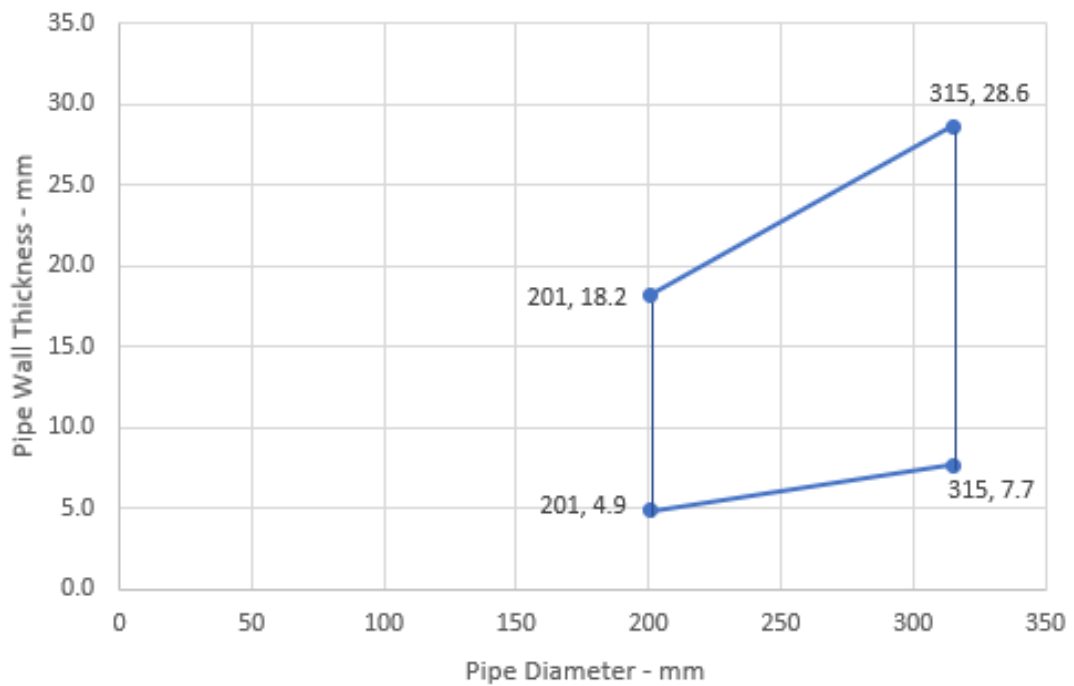



### PE Pipes 126-160 mm Diameter - E 240 U/U, EI 120 U/U

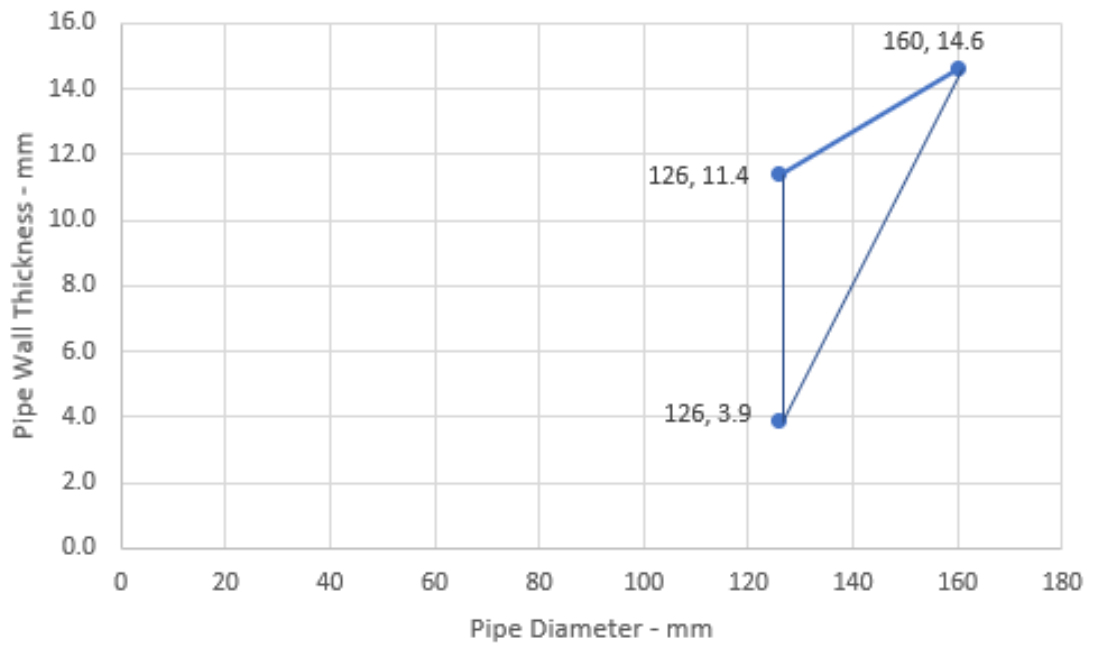

### PE Pipes - EI 60 C/C

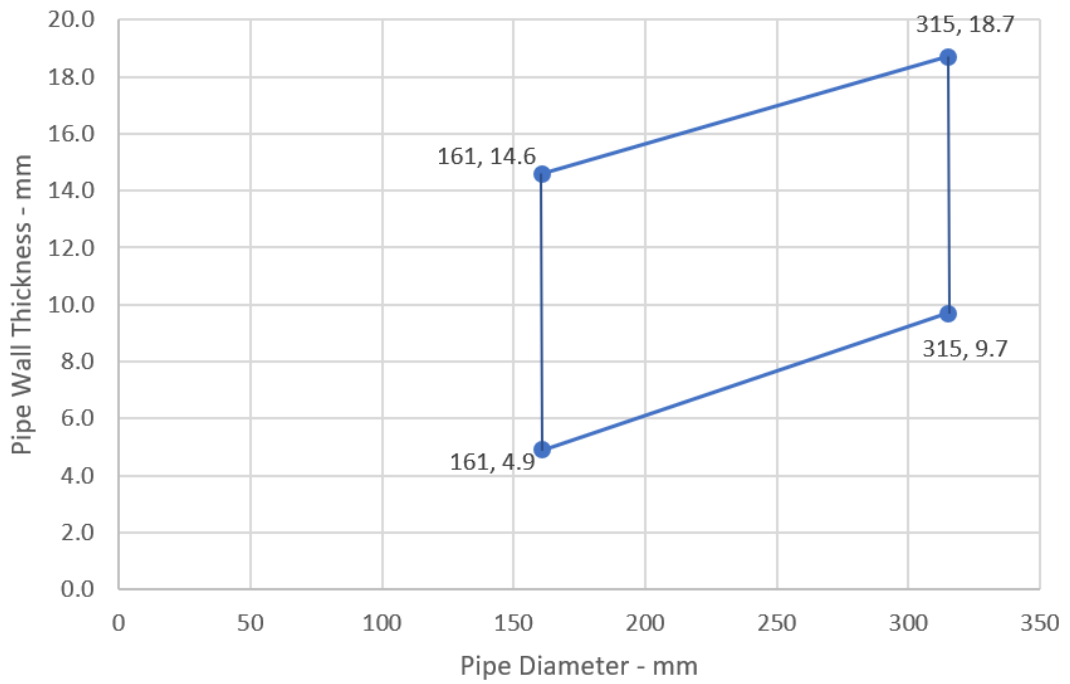

## A.2.7 Bostik FP 340 Pipe Wrap penetration seals, in 150 mm thick Bostik FP 370 Fireseal Mortar seals in rigid floors, with plastic pipes

**Penetration Seal:** Plastic pipes fitted at any position within the aperture (min. separation 30 mm from seal edges and from other services), with 150 mm Bostik FP 370 Fireseal Mortar to the bottom surface of the floor. Bostik FP 340 Pipe Wraps are required to be fitted to the bottom of the seal, as indicated below. Maximum seal size 2400 mm x 1200 mm.

Construction details:

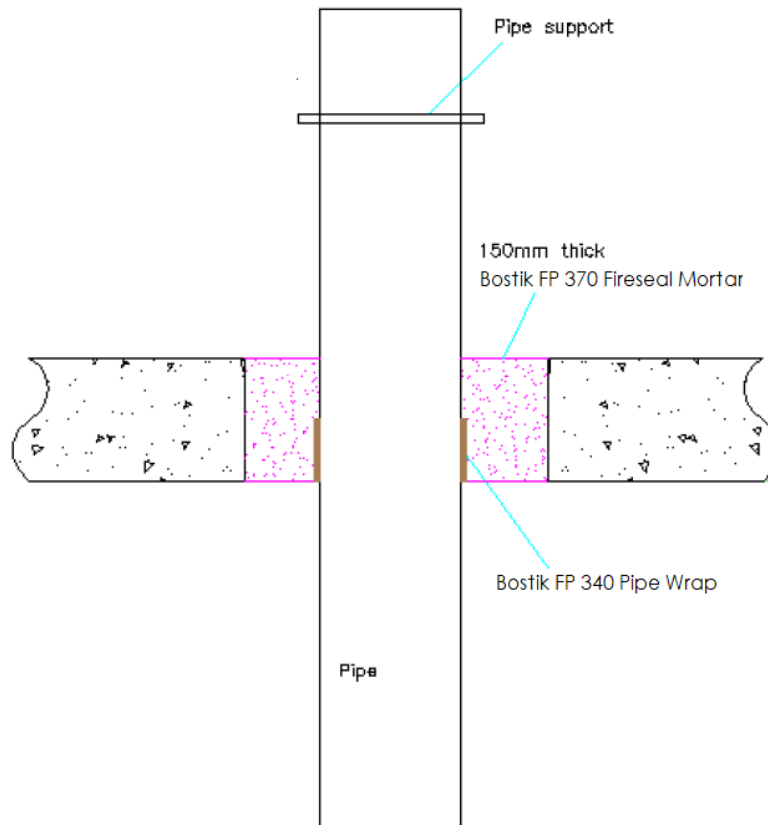

**Configuration 1**

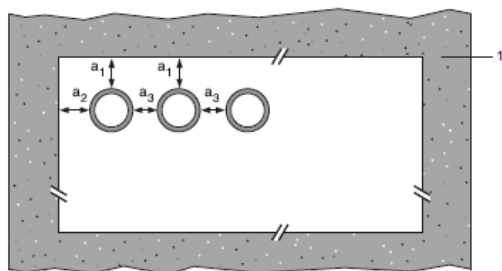

**Configuration 2**

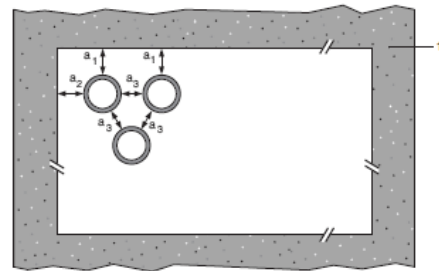

**Key**

1 Supporting construction

a1 Pipe / top edge of seal separation

a2 Pipe / side edge of seal separation

a3 Pipe / pipe separation

### A.2.7.1

Services	Wrap	Permitted configuration for seal separation	Classification
<b>PVC-U pipe according to EN 1329-1, EN 1452-1 and EN 1453-1, PVC-C according to EN 1566-1</b>			
Up to 40 mm diameter/1.8-3.7 mm wall*	50 x 1.8	1 & 2	EI 120 U/U
Up to 125 mm diameter / 4.8-7.4 mm wall*	50 x 7.2 mm		EI 60 U/U
Up to 160 mm diameter/9.5 mm wall*	75 x 7.2 mm		E 120 U/U, EI 30 U/U
<b>PP pipe according to EN 1451-1</b>			
Up to 40 mm diameter/1.8-5.5 mm wall*	50 x 1.8	1 & 2	EI 120 U/U
Up to 125 mm diameter / 11.4 mm wall*	50 x 7.2 mm		EI 240 U/U
Up to 160 mm diameter/14.6 mm wall*	75 x 7.2 mm		EI 240 U/U
<b>PE pipe according to EN 1519-1, EN 12201-2 and EN 12666-1, ABS according to EN 1455-1 and pipes made from SAN+PVC according to EN 1565-1</b>			
Up to 40 mm diameter/2.4-3.7 mm wall*	50 x 1.8 mm	1 & 2	EI 240 U/U
Up to 110 mm diameter/3.4-10 mm wall*	75 x 5.4 mm		EI 240 U/U
Up to 125 mm diameter/11.4 mm wall*	50 x 7.2 mm		EI 240 U/U
Up to 160 mm diameter/4.9-14.6 mm wall*	75 x 7.2 mm		EI 120 U/U

\* Typical pipe diameters shown, see below graph for intermediate sizes

### PVC-U Pipes - E 60 U/U, EI 30 U/U

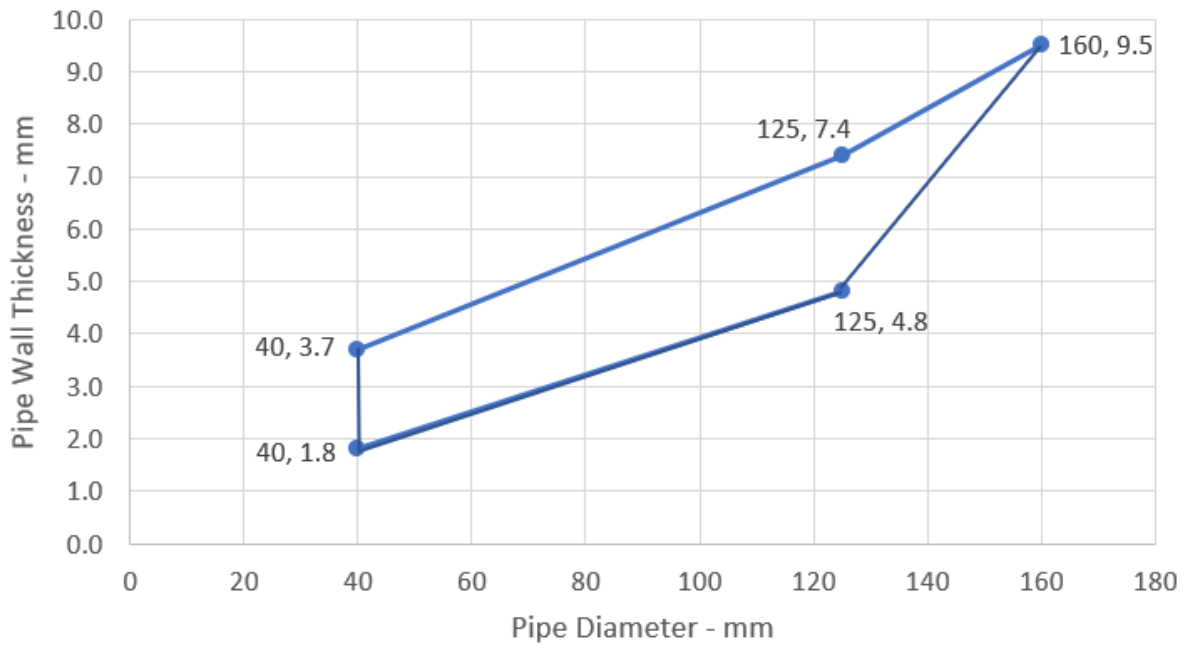

### PP Pipes - E 120 U/U

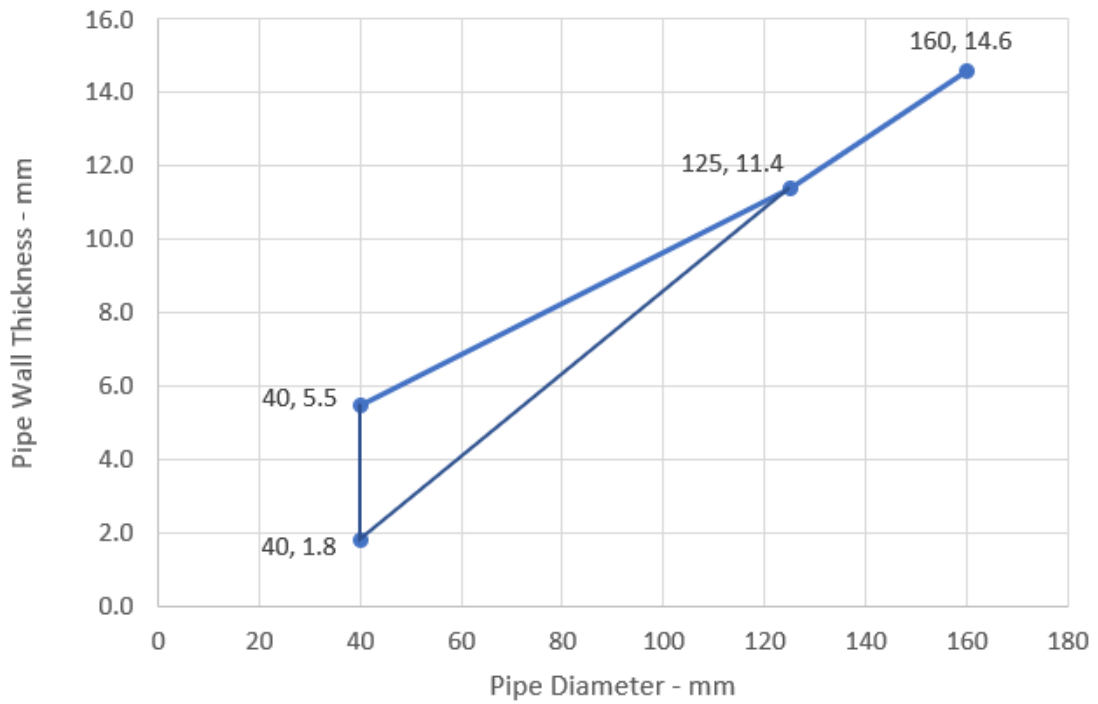

### PE Pipes - EI 120 U/U

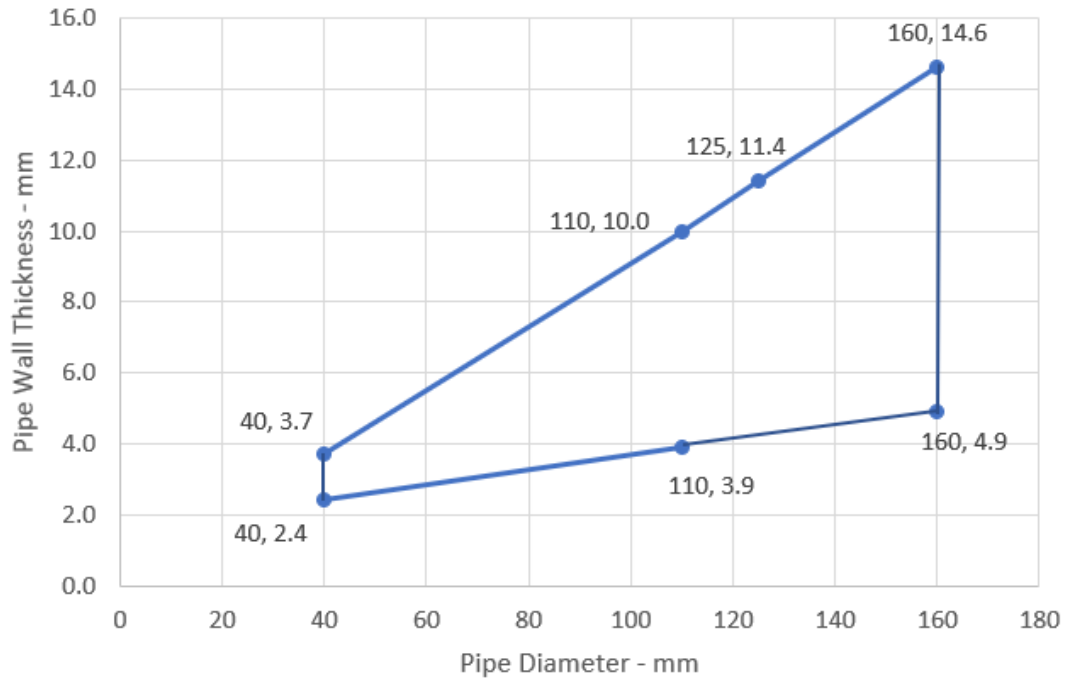

**A.2.8 Bostik FP 340 Pipe Wrap penetration seals, in 50 mm deep Bostik FP 370 Fireseal Mortar seals, backed with 50 mm stone wool, in rigid floors, with plastic pipes**

**Penetration Seal:** Plastic pipes (single) fitted at any position within the aperture (min. separation 30 mm from seal edges and 30 mm from other services), with 50 mm Bostik FP 370 Fireseal Mortar flush with the top of floor, backed with 50 mm stone wool 150 kg/m<sup>3</sup>. Bostik FP 340 Pipe Wraps are required to be fitted into the mortar seal.

Construction details:

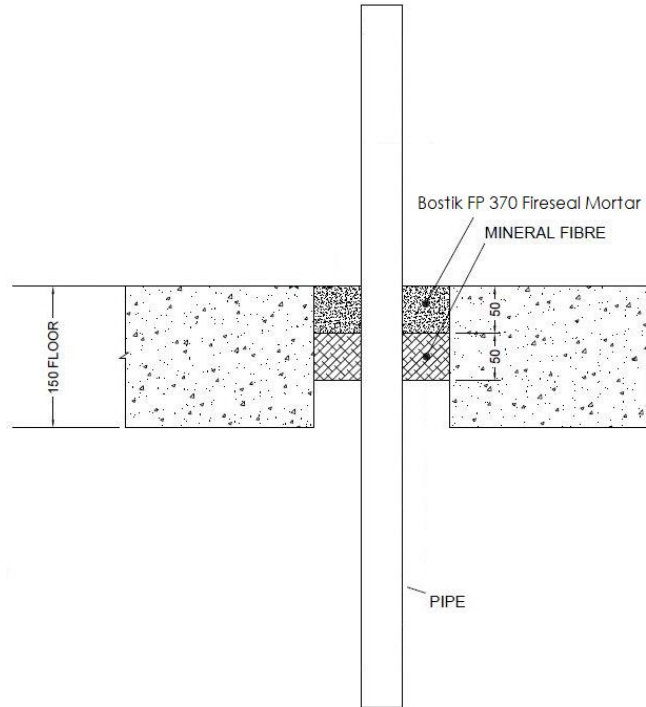

**A.2.8.1**

Services	Wrap	Maximum aperture	Classification
<b>PE pipe according to EN 1519-1, EN 12201-2 and EN 12666-1, ABS according to EN 1455-1 and pipes made from SAN+PVC according to EN 1565-1</b>			
110 mm diameter / 4.3 mm wall	50 x 2 mm	2400 x 1200 mm	<b>EI 60 C/C</b>

### A.3 Flexible and rigid wall constructions with a minimum thickness 100 mm

#### A.3.1 Bostik FP 340 Pipe Wrap penetration seal for insulated metal pipes, in seals comprising 25 mm deep Bostik FP 370 Fireseal Mortar to both faces backed with 50 mm mineral fibre board, installed within flexible or rigid wall

**Penetration Seal:** CS (Continuous Sustained) insulated metallic pipes fitted at any position within the aperture (min. separation 30 mm from seal edges), with 25 mm Bostik FP 370 Fireseal Mortar to both sides of the wall, backed with 50 mm stone wool board 150 kg/m<sup>3</sup> or 50 mm Bostik FP 370 Fireseal Mortar to both sides of the wall without backing\*. Bostik FP 340 Pipe Wraps are required to be fitted to both faces of the seal.

Construction details:

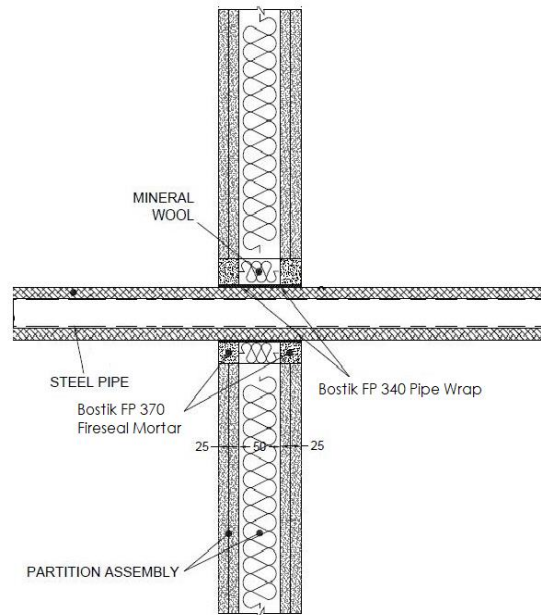

\* Maximum seal size of 2400 mm wide x 1200 mm high

**A.3.1.1**

Services	Wrap	Insulation	Classification
Mild or stainless steel pipe			
40 mm diameter/1-14.2 mm wall	2 off 50 x 1.8 mm Bostik FP 340 Pipe Wrap, one fitted flush to each face of seal		<b>EI 120 C/U</b>
40 mm diameter/1-14.2 mm wall*			
50 mm diameter/1.3-14.2 mm wall*			
60 mm diameter/1.6-14.2 mm wall*			
75 mm diameter/2-14.2 mm wall*	2 off 50 x 3.6 mm Bostik FP 340 Pipe Wrap, one fitted flush to each face of seal	13 mm Elastomeric insulation minimum class B-s3,d0 or PE Foam insulation	<b>E 120 C/U, EI 60 C/U</b>
90 mm diameter/2.4-14.2 mm wall*			
100 mm diameter/2.7-14.2 mm wall*			
115 mm diameter/3.1-14.2 mm wall*			
140 mm diameter/3.8-14.2 mm wall*			
165 mm diameter/ 4.5-14.2 mm wall*			

\* Typical pipe diameters shown, see below graph for intermediate sizes

**Pipe diameter vs Wall thickness**

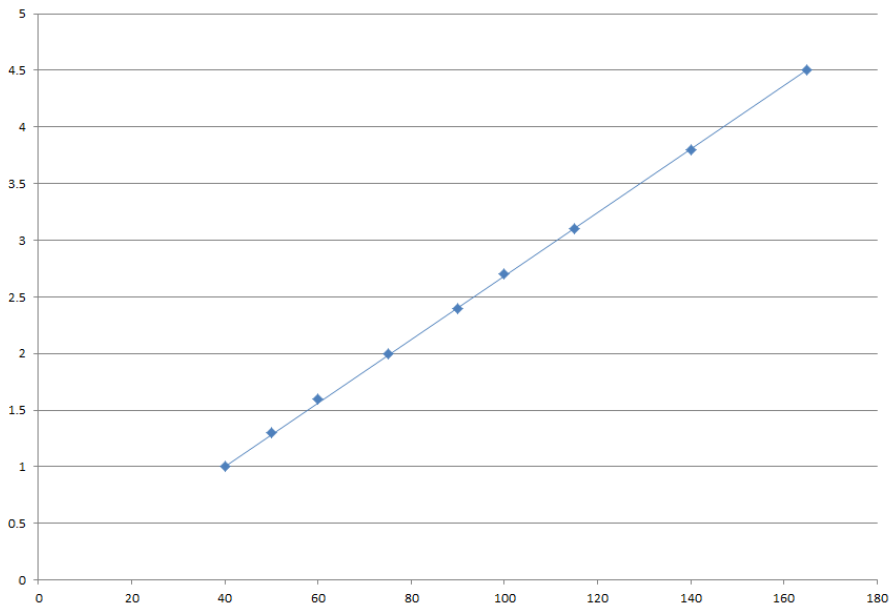



**A.3.2 Bostik FP 340 Pipe Wrap penetration seal for composite pipes, in seals comprising 25 mm deep Bostik FP 370 Fireseal Mortar to both faces backed with 50 mm mineral fibre board, installed within flexible or rigid wall**

**Penetration Seal:** 500 mm (min.)\* LI (Local Interrupted) or CI (Continuous Interrupted) insulated metallic ( and composite) pipes (single) fitted at any position within the aperture (min. separation 30 mm from seal edges and from other services), with 25 mm Bostik FP 370 Fireseal Mortar to both sides of the wall backed with 50 mm stone wool board 150 kg/m<sup>3</sup>. Maximum seal size 2400 mm wide x 1200 mm high

Construction details:

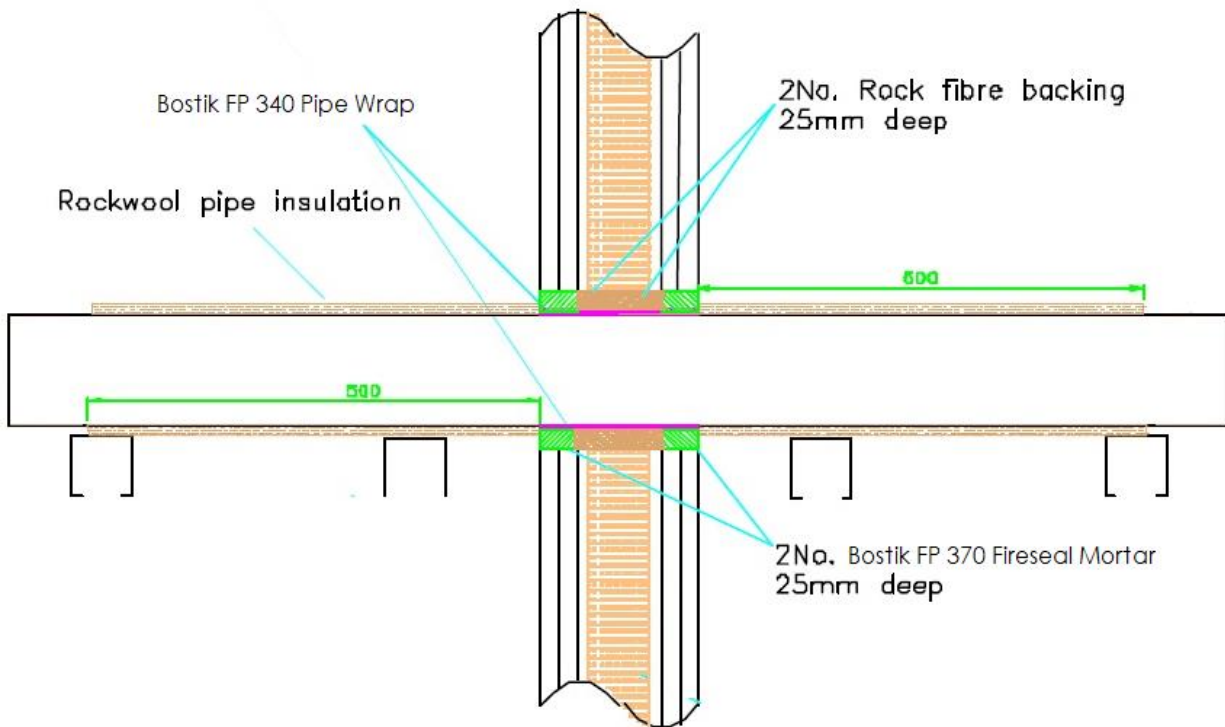

**A.3.2.1**

Services	Insulation	Classification
Geberit Mepla MLC (PE-Xb/Aluminium/PE-HD) pipe	Minimum 20 mm stone wool, minimum 80 kg/m <sup>3</sup>	EI 120 C/C
16 mm diameter/2.25 mm wall		
20 mm diameter/2.5 mm wall		
26 mm diameter/3 mm wall		
32 mm diameter/3 mm wall		
40 mm diameter/3.5 mm wall		
50 mm diameter/4 mm wall		
63 mm diameter/4.5 mm wall		
75 mm diameter/4.7 mm wall		

**A.3.3 Bostik FP 340 Pipe Wrap penetration seal for insulated metal & composite pipes, in seals comprising 25 mm deep Bostik FP 370 Fireseal Mortar to both faces backed with 50 mm mineral fibre board, installed within flexible or rigid wall**

**Penetration Seal:** CS (Continuous Sustained) insulated metallic and composite pipes fitted at any position within the aperture (min. separation 25 mm from seal edges), with 25 mm Bostik FP 370 Fireseal Mortar to both sides of the wall, backed with 25 mm stone wool 150 kg/m<sup>3</sup>\*. Bostik FP 340 Pipe Wraps are required to be fitted to both faces of the seal. Maximum seal size 2400 mm wide x 1200 mm long

Construction details:

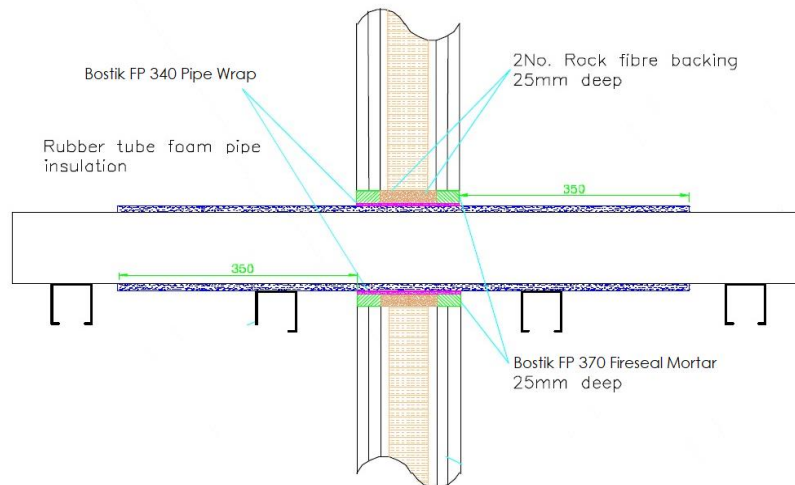

**A.3.3.1**

Services	Wrap	Insulation	Classification
Copper pipe			
12-54 mm diameter/1-1.2 mm wall	50 x 3.6 mm Bostik FP 340 Pipe Wrap fitted to both sides of the seal	9-25 mm Elastomeric insulation minimum class B-s3,d0 or PE Foam insulation	<b>EI 120 C/C</b>
Geberit Mepla MLC (PE-Xb/Aluminium/PE-HD pipe)			
16 mm diameter/2.25 mm wall	50 x 3.6 mm Bostik FP 340 Pipe Wrap fitted to both sides of the seal	9-25 mm Elastomeric insulation minimum class B-s3,d0 or PE Foam insulation	<b>EI 120 C/C</b>
20 mm diameter/2.5 mm wall			
26 mm diameter/3 mm wall			
32 mm diameter/3 mm wall			
40 mm diameter/3.5 mm wall			
50 mm diameter/4 mm wall			
63 mm diameter/4.5 mm wall			
75 mm diameter/4.7 mm wall			

**A.3.4 Bostik FP 340 Pipe Wrap penetration seal for insulated metal pipes, in seals comprising 50 mm deep Bostik FP 370 Fireseal Mortar to both faces, installed within flexible or rigid wall**

**Penetration Seal:** CS (Continuous Sustained) insulated metallic pipes fitted at any position within the aperture (min. separation 30 mm from seal edges), 50 mm Bostik FP 370 Fireseal Mortar to both sides of the wall without backing\*. Bostik FP 340 Pipe Wraps are required to be fitted to both faces of the seal.

Construction details:

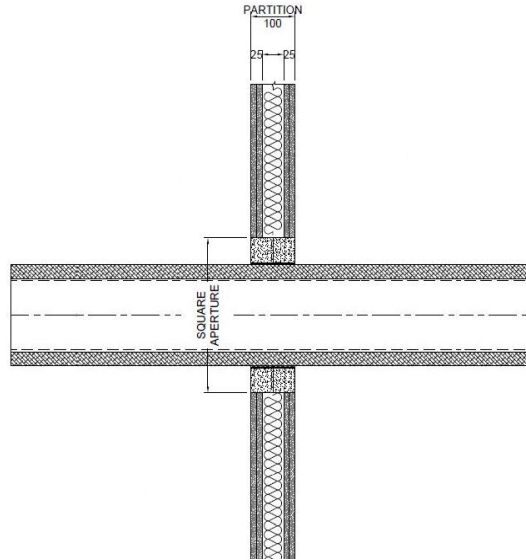

\* Maximum seal size of 2400 mm wide x 1200 mm high

**A.3.4.1**

Services	Wrap	Insulation	Classification
Mild or stainless steel pipe	2 off 50 x 3.6 mm Bostik FP 340 Pipe Wrap, one fitted flush to each face of seal	13 -32 mm Elastomeric insulation minimum class B-s3,d0 or PE Foam insulation	<b>E 120 C/U, EI 60 C/U</b>
40 mm diameter/1-14.2 mm wall*			
50 mm diameter/1.3-14.2 mm wall*			
60 mm diameter/1.6-14.2 mm wall*			
75 mm diameter/2-14.2 mm wall*			
90 mm diameter/2.4-14.2 mm wall*			
100 mm diameter/2.7-14.2 mm wall*			
115 mm diameter/3.1-14.2 mm wall*			
140 mm diameter/3.8-14.2 mm wall*			
165 mm diameter/ 4.5-14.2 mm wall*			

\* Typical pipe diameters shown, see below graph for intermediate sizes

**Pipe diameter vs Wall thickness**

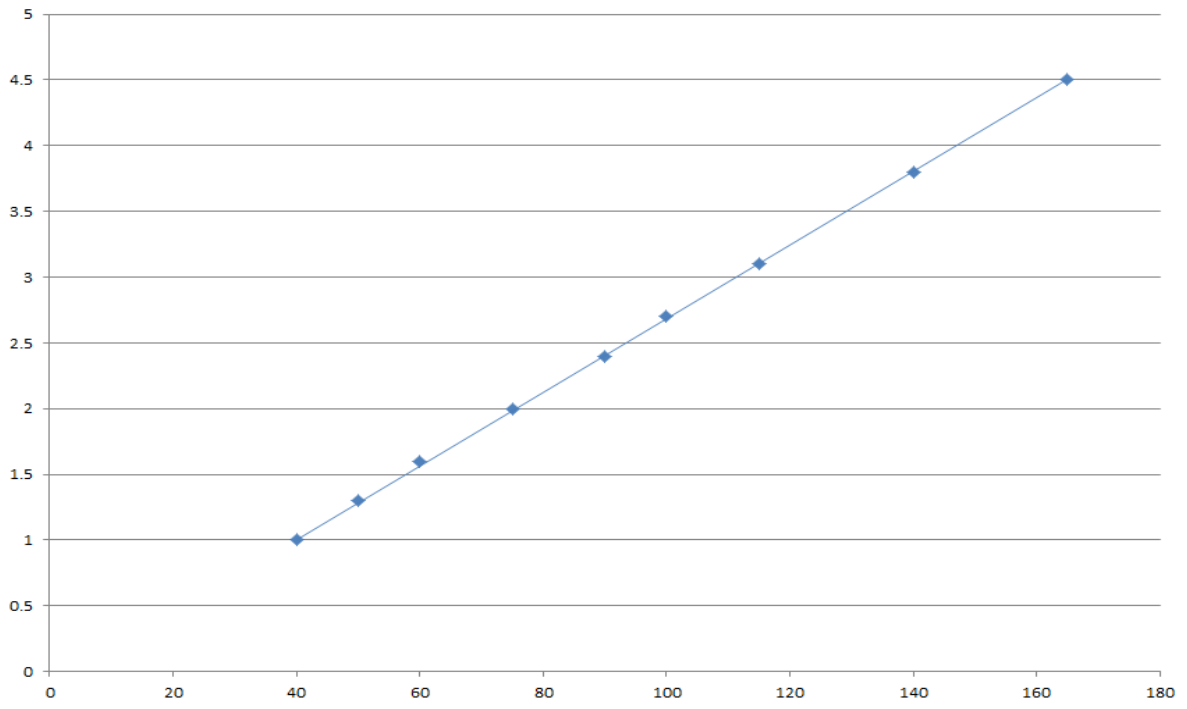

#### A.4 Rigid wall constructions with floor thickness of minimum 150 mm

##### A.4.1 Bostik FP 340 Pipe Wrap penetration seal for insulated metal pipes, in 1x Bostik FP 320 Fire Batt 2-S seals, in rigid walls

**Penetration Seal:** CS (Continuous Sustained) insulated metallic pipes fitted at any position within the aperture, with 60 mm Bostik FP 320 Fire Batt 2-S to either side of the wall (or anywhere in between). Bostik FP 340 Pipe Wraps are required to be fitted around combustible pipe insulation.

Construction details:

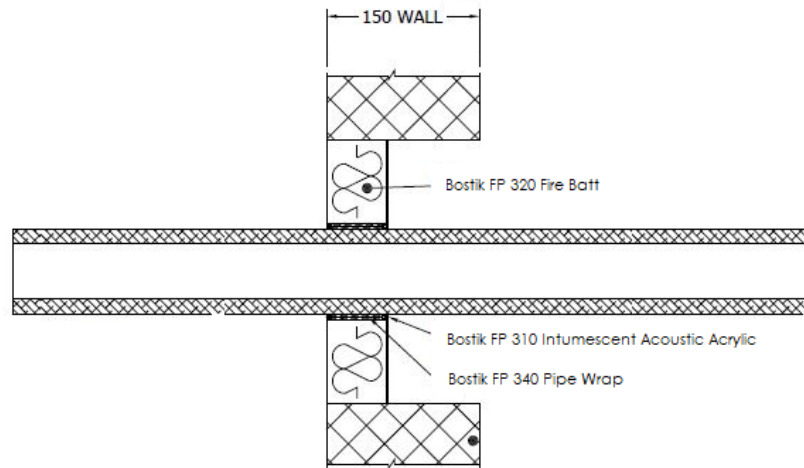

##### A.4.1.1

Services	Wrap	Insulation	Classification
Mild or stainless steel pipe			
165 mm diameter/ 4.5-14.2 mm wall	50 x 1.8 mm Bostik FP 340 Pipe Wrap fitted centrally	9-25 mm Elastomeric insulation minimum class B-s3,d0 or PE Foam insulation	<b>E 120 U/C, E 120 C/U, E 120 C/C, EI 45 U/C, EI 45 C/U, EI 45 C/C</b>

#### A.4.2 Bostik FP 340 Pipe Wrap penetration seal for insulated metal pipes, in 2x Bostik FP 320 Fire Batt 2-S seals, in rigid walls

**Penetration Seal:** Plastic pipes fitted at any position within the aperture, with 60 mm Bostik FP 320 Fire Batt 2-S to both sides of the wall. Bostik FP 340 Pipe Wraps are required to be fitted around pipes. Min. 30 mm separation between pipes.

Construction details:

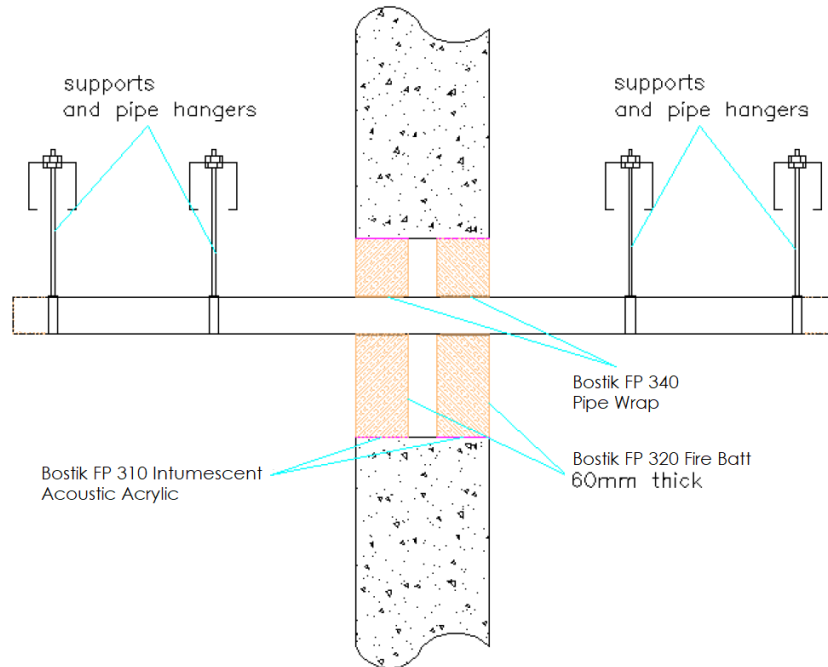

##### A.4.2.1

Services	Wrap	Classification
<b>PVC-U pipe according to EN 1329-1, EN 1452-1 and EN 1453-1 and PVC-C according to EN 1566-1</b>		
Up to 40 mm diameter / 1.9-3.0 mm wall	50 x 1.8 mm	<b>EI 240 U/C</b>
Up to 110 mm diameter / 2.7-6.6 mm wall	50 x 3.6 mm	
Up to 125 mm diameter / 4.7-7.4 mm wall	50 x 7.2 mm	
Up to 160 mm diameter / 4.0-9.5 mm wall*	50 x 10.8 mm	
Up to 315 mm diameter/7.7-12.1 mm wall thickness*#	75 x 18 mm	<b>EI 120 C/C</b>
Up to 400 mm diameter/9.8-15.3 mm wall thickness*#	75 x 28.8 mm	<b>EI 120 C/C</b>
<b>PE pipe according to EN 1519-1, EN 12201-2 and EN 12666-1, ABS according to EN 1455-1 and pipes made from SAN+PVC according to EN 1565-1</b>		
Up to 40 mm diameter / 2.4-4.6 mm wall	50 x 1.8 mm	<b>EI 240 U/C</b>
Up to 110 mm diameter / 3.4-10.0 mm wall	50 x 3.6 mm	
Up to 125 mm diameter / 3.9-7.4 mm wall	50 x 7.2 mm	
Up to 160 mm diameter / 4.9-9.5 mm wall	50 x 10.8 mm	
<b>PP pipe according to EN 1451-1</b>		
Up to 40 mm diameter / 1.8-5.5 mm wall	50 x 1.8 mm	<b>EI 240 U/C</b>
Up to 110 mm diameter / 2.7-10.0 mm wall	50 x 3.6 mm	<b>EI 240 C/C</b>
Up to 125 mm diameter / 3.1-11.4 mm wall	50 x 7.2 mm	
Up to 160 mm diameter / 4.9-14.6 mm wall	50 x 10.8 mm	

\* Typical pipe diameters shown, see below graph for intermediate sizes.

# Configuration 1 & 2

### PVC-U Pipes - EI 120 C/C

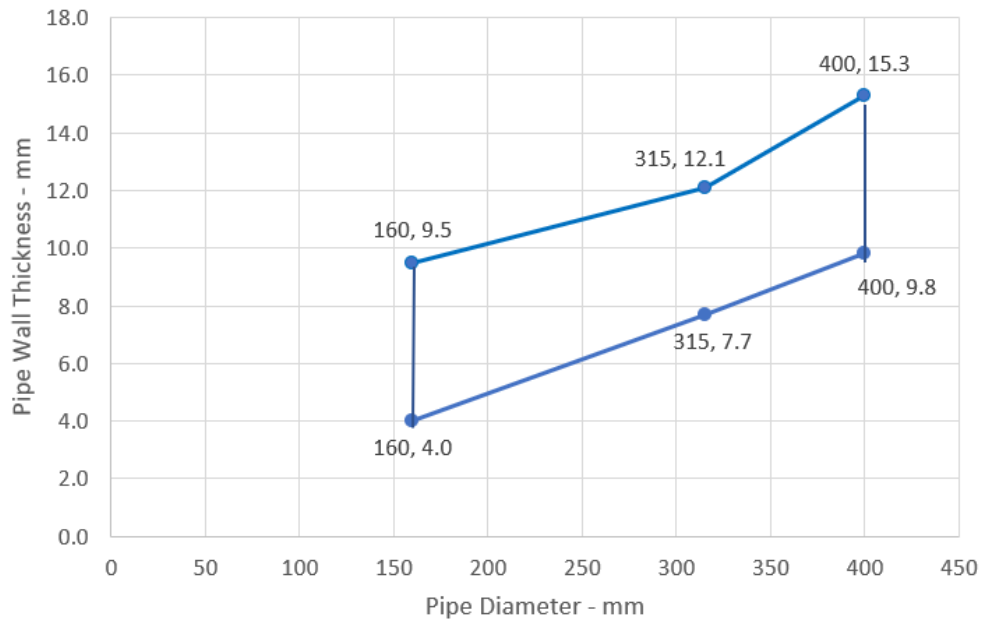

**A.5 Rigid floor constructions with floor thickness of minimum 150 mm**

**A.5.1 Bostik FP 340 Pipe Wrap penetration seal for plastic pipes, in 1x Bostik FP 320 Fire Batt 2-S, in rigid floors**

**Penetration Seal:** Combustible pipes fitted at any position within the aperture, with 50 mm Bostik FP 320 Fire Batt 2-S at mid-depth of the floor. Bostik FP 340 Pipe Wraps are required to be fitted around combustible pipe insulation. Maximum aperture size 2400 mm x 1200 mm

Construction details:

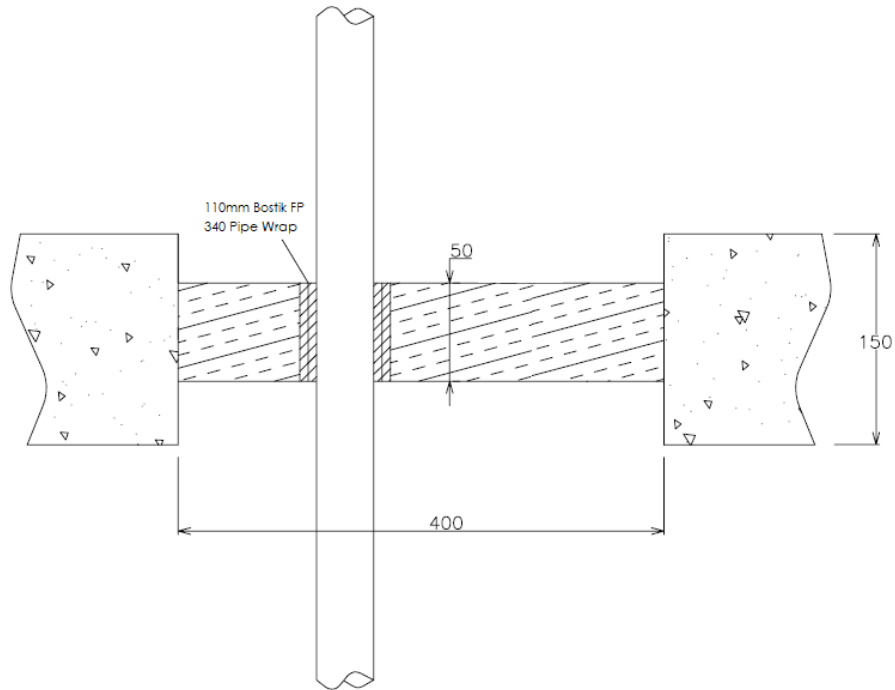

**A.5.1.1**

Services	Wrap	Classification
PVC-U pipe according to EN 1329-1, EN 1452-1 and EN 1453-1* 110 mm diameter/ 3.4mm wall	50 x 3.6 mm Bostik FP 340 Pipe Wrap	<b>EI 90 U/C, EI 90 C/C</b>



### A.5.2 Bostik FP 340 Pipe Wrap penetration seal for insulated metal pipes, in 1x Bostik FP 320 Fire Batt 2-S, in rigid floors

**Penetration Seal:** CS (Continuous Sustained) insulated metallic pipes fitted at any position within the aperture, with 60 mm Bostik FP 320 Fire Batt 2-S to either side of the floor (or anywhere in between). Bostik FP 340 Pipe Wraps are required to be fitted around combustible pipe insulation. Maximum aperture size 2400 mm x 1200 mm

Construction details:

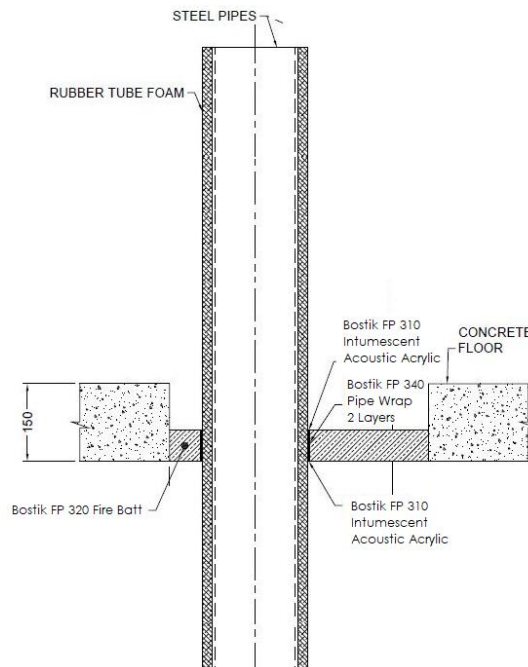

#### A.5.2.1

Services	Wrap	Insulation	Classification
Mild or stainless steel pipe			
165 mm diameter/ 4.5-14.2 mm wall	50 x 3.6 mm Bostik FP 340 Pipe Wrap fitted at bottom of seal	13 mm Elastomeric insulation minimum class B-s3,d0 or foil faced Phenolic Foam insulation	<b>E 90 C/U, EI 45 C/U</b>
		19 mm Elastomeric insulation minimum class B-s3,d0 or foil faced Phenolic Foam insulation	<b>EI 90 C/U</b>

### A.5.3 Bostik FP 340 Pipe Wrap penetration seal for insulated metal pipes in 2x Bostik FP 320 Fire Batt 2-S (separated), in rigid floors

**Penetration Seal:** CS (Continuous Sustained) insulated metallic pipes fitted at any position within the aperture, with 60 mm Bostik FP 320 Fire Batt 2-S to both sides of the floor. Bostik FP 340 Pipe Wraps are required to be fitted around combustible pipe insulation at the soffit. Maximum aperture size 2400 mm x 1200 mm

Construction details:

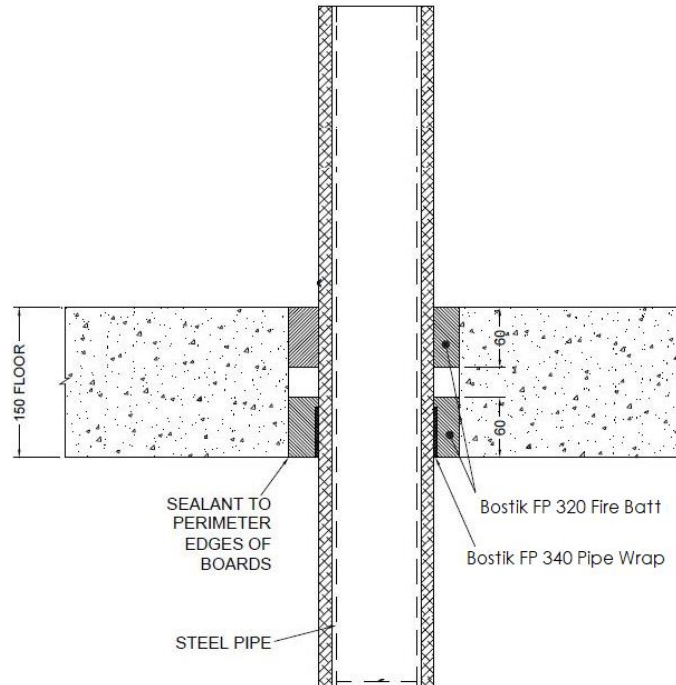

#### A.5.3.1 Double side penetration seal with pipes

Services	Wrap	Insulation	Classification
Mild or stainless steel pipe			
40 mm diameter/ 1-14.2 mm wall	50 x 1.8 mm Bostik FP 340 Pipe Wrap	13 mm Elastomeric insulation minimum class B-s3,d0 or foil faced Phenolic Foam insulation	<b>E 180 C/U, EI 120 C/U</b>

**A.5.4 Bostik FP 340 Pipe Wrap penetration seal for insulated metal pipes, in 2x Bostik FP 320 Fire Batt 2-S (back to back), in rigid floors**

**Penetration Seal:** CS (Continuous Sustained) insulated metallic and composite pipes fitted at any position within the aperture, with two layers of 60 mm Bostik FP 320 Fire Batt 1-S installed together to either side of the floor (or anywhere in between). Bostik FP 340 Pipe Wraps are required to be fitted around combustible pipe insulation at the bottom of the seal. Maximum aperture size 2400 mm x 1200 mm

Construction details:

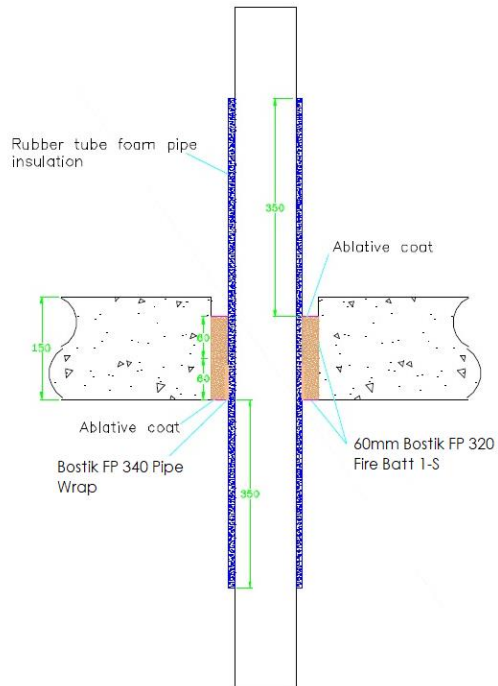

**A.5.4.1**

Services	Wrap	Insulation	Classification
Copper pipe			
12-54 mm diameter/1-1.2 mm wall	50 x 3.6 mm Bostik FP 340 Pipe Wrap fitted to both sides of the seal	9-13 mm Elastomeric insulation minimum class B-s3,d0 or foil faced Phenolic Foam insulation	<b>E240 C/C, EI 60 C/C</b>
12-54 mm diameter/1-1.2 mm wall		13-25 mm Elastomeric insulation minimum class B-s3,d0 or foil faced Phenolic Foam insulation	<b>E 180 C/C, EI 45 C/C</b>
<b>Geberit Mepla MLC (PE-Xb/Aluminium/PE-HD pipe)</b>			
16 mm diameter/2.25 mm wall	50 x 3.6 mm Bostik FP 340 Pipe Wrap fitted to both sides of the seal	9 mm Elastomeric insulation minimum class B-s3,d0 or foil faced Phenolic Foam insulation	<b>EI 120 C/C</b>
20 mm diameter/2.5 mm wall			
26 mm diameter/3 mm wall			
32 mm diameter/3 mm wall			
40 mm diameter/3.5 mm wall			
50 mm diameter/4 mm wall			
63 mm diameter/4.5 mm wall		13-25 mm Elastomeric insulation minimum class B-s3,d0 or foil faced Phenolic Foam insulation	<b>E 60 C/C, EI 45 C/C</b>
75 mm diameter/4.7 mm wall			
16 mm diameter/2.25 mm wall			
20 mm diameter/2.5 mm wall			
26 mm diameter/3 mm wall			
32 mm diameter/3 mm wall			
40 mm diameter/3.5 mm wall			
50 mm diameter/4 mm wall			
63 mm diameter/4.5 mm wall			
75 mm diameter/4.7 mm wall			

**A.6 Flexible wall constructions according to 2. 1)**

**A.6.1 Bostik FP 340 Pipe Wrap penetration seal for insulated metal pipes, in 2x Bostik FP 320 Fire Batt 1-S in flexible or rigid walls**

**Penetration Seal:** CS (Continuous Sustained) insulated metallic pipes fitted at any position within the aperture, with 50 mm Bostik FP 320 Fire Batt 1-S to both sides of the wall. Minimum separation between penetration seals and seal edges of 30 mm. Bostik FP 340 Pipe Wraps are required to be fitted around the pipe insulation.

Construction details:

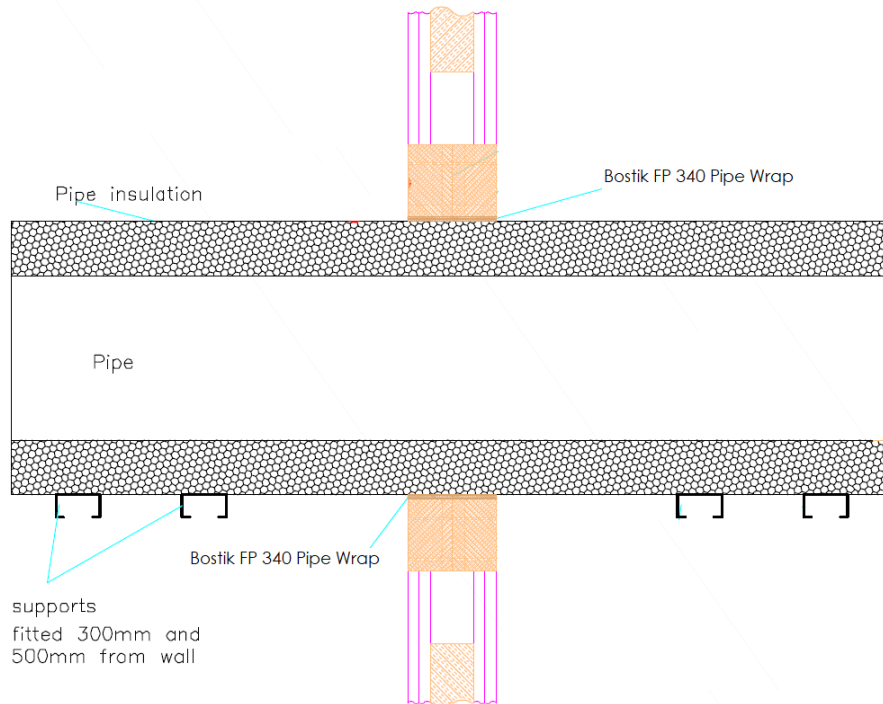

**Configuration 1**

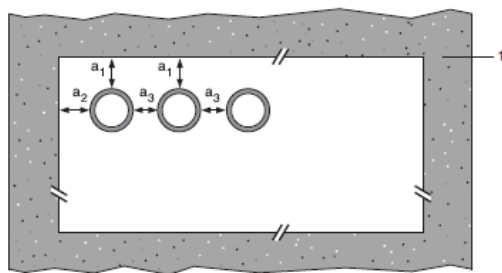

**Configuration 2**

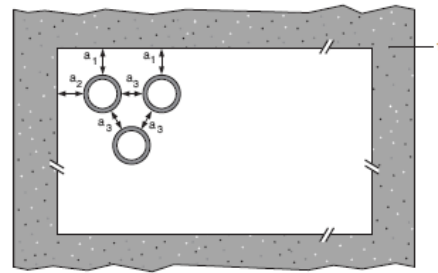

**Key**

- 1 Supporting construction
- a1 Pipe / top edge of seal separation
- a2 Pipe / side edge of seal separation
- a3 Pipe / pipe separation

**A.6.1.1**

Mild or stainless steel pipe	Insulation	Bostik FP 340 Pipe Wrap	Classification
40 mm diameter/1-14.2 mm wall*	32-50 mm thick Elastomeric insulation minimum class B-s3,d0 or PE Foam insulation	3 layers 50 x 1.8 mm	EI 90 C/U
50 mm diameter/1.2-14.2 mm wall*			
60 mm diameter/1.4-14.2 mm wall*			
75 mm diameter/1.6-14.2 mm wall*			
90 mm diameter/1.9-14.2 mm wall*			
100 mm diameter/2.1-14.2 mm wall*			
115 mm diameter/2.4-14.2 mm wall*			
140 mm diameter/2.9-14.2 mm wall*			
165 mm diameter/ 3.4-14.2 mm wall*			
180 mm diameter/ 3.6-14.2 mm wall*			
200 mm diameter/ 4.0-14.2 mm wall*			
219 mm diameter/ 4.3-14.2 mm wall*			
250 mm diameter/ 5.0-14.2 mm wall*			
300 mm diameter/ 5.9-14.2 mm wall*			
324 mm diameter/ 6.35-14.2 mm wall*			

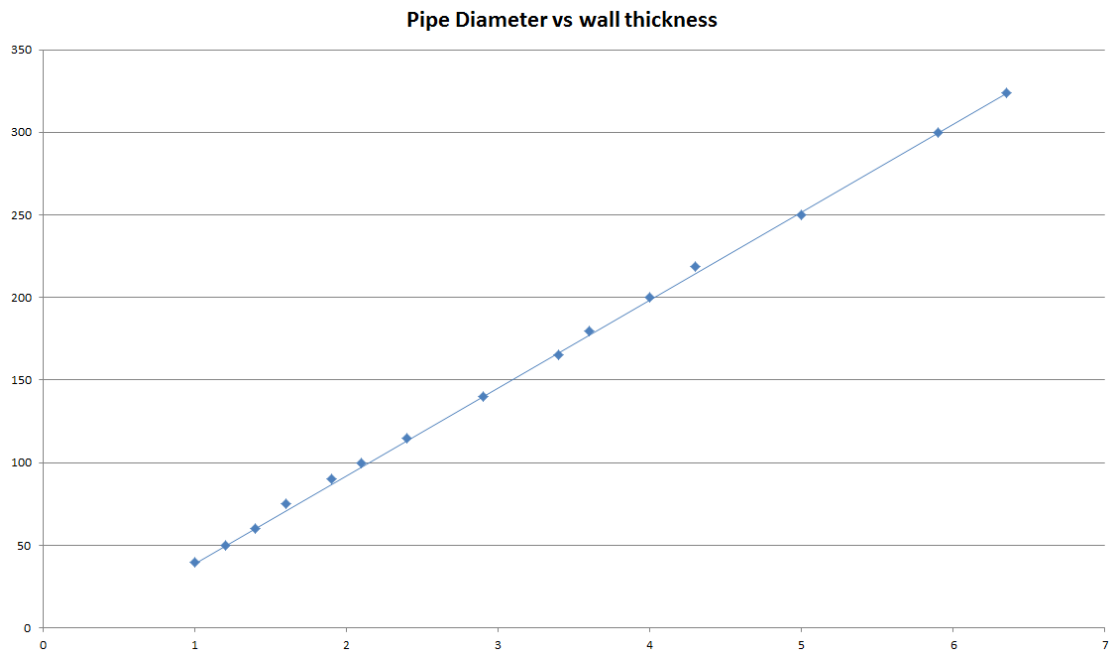

### A.6.2 Bostik FP 340 Pipe Wrap penetration seal for insulated metal pipes, in 2x Bostik FP 320 Fire Batt 1-S, in flexible or rigid walls

**Penetration Seal:** CS (Continuous Sustained) insulated metallic pipes fitted at any position within the aperture, with 50 mm Bostik FP 320 Fire Batt 1-S to both sides of the wall. Bostik FP 340 Pipe Wraps are required to be fitted around the pipe insulation.

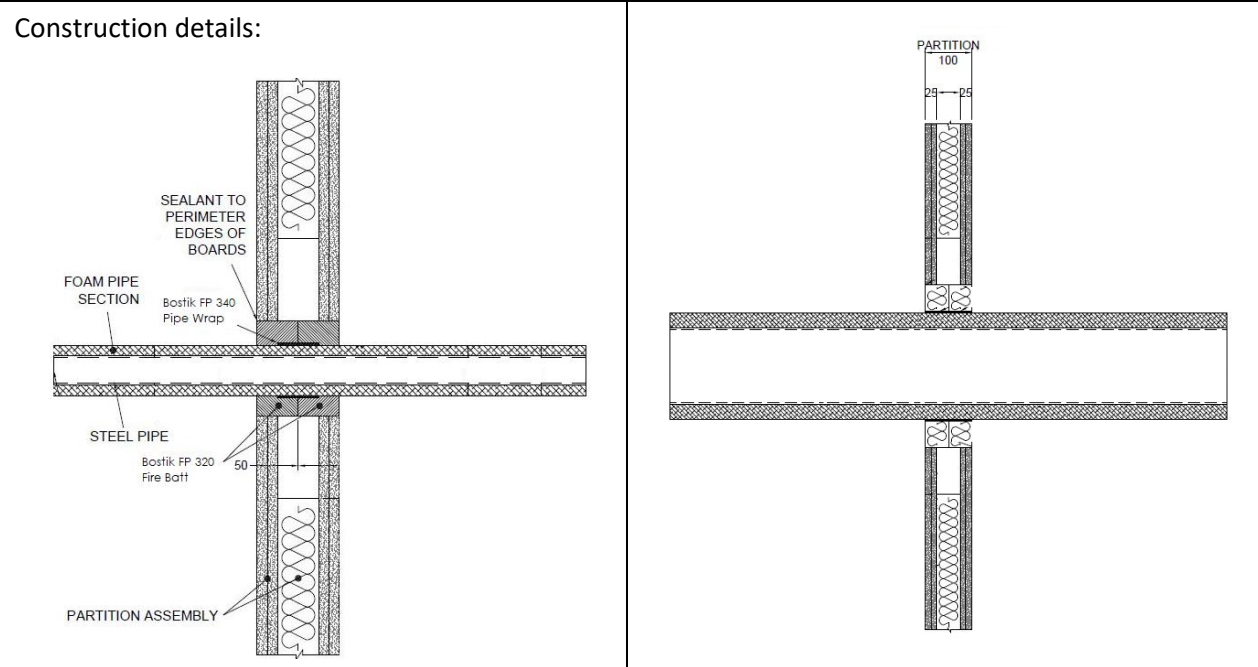

#### A.6.2.1

Services	Wrap	Insulation	Classification
Mild or stainless steel pipe			
40 mm diameter/1-14.2 mm wall	50 x 1.8 mm Bostik FP 340 Pipe Wrap fitted centrally	13 mm Elastomeric insulation minimum class B-s3,d0 or PE Foam insulation	EI 120 U/C, EI 120 U/U, EI 120 C/U, EI 120 C/C
40 mm diameter/1-14.2 mm wall*	2 off 50 x 3.6 mm Bostik FP 340 Pipe Wrap, one fitted flush to each face of seal	13 - 32mm Elastomeric insulation minimum class B-s3,d0 or PE Foam insulation	E 120 U/C, E 120 U/U, E 120 C/U, E 120 C/C, EI 60 U/C, EI 60 U/U, EI 60 C/U, EI 60 C/C
50 mm diameter/1.3-14.2 mm wall*			
60 mm diameter/1.6-14.2 mm wall*			
75 mm diameter/2-14.2 mm wall*			
90 mm diameter/2.4-14.2 mm wall*			
100 mm diameter/2.7-14.2 mm wall*			
115 mm diameter/3.1-14.2 mm wall*			
140 mm diameter/3.8-14.2 mm wall*			
165 mm diameter/ 4.5-14.2 mm wall*			

\* Typical pipe diameters shown, see below graph for intermediate sizes

Pipe diameter vs Wall thickness

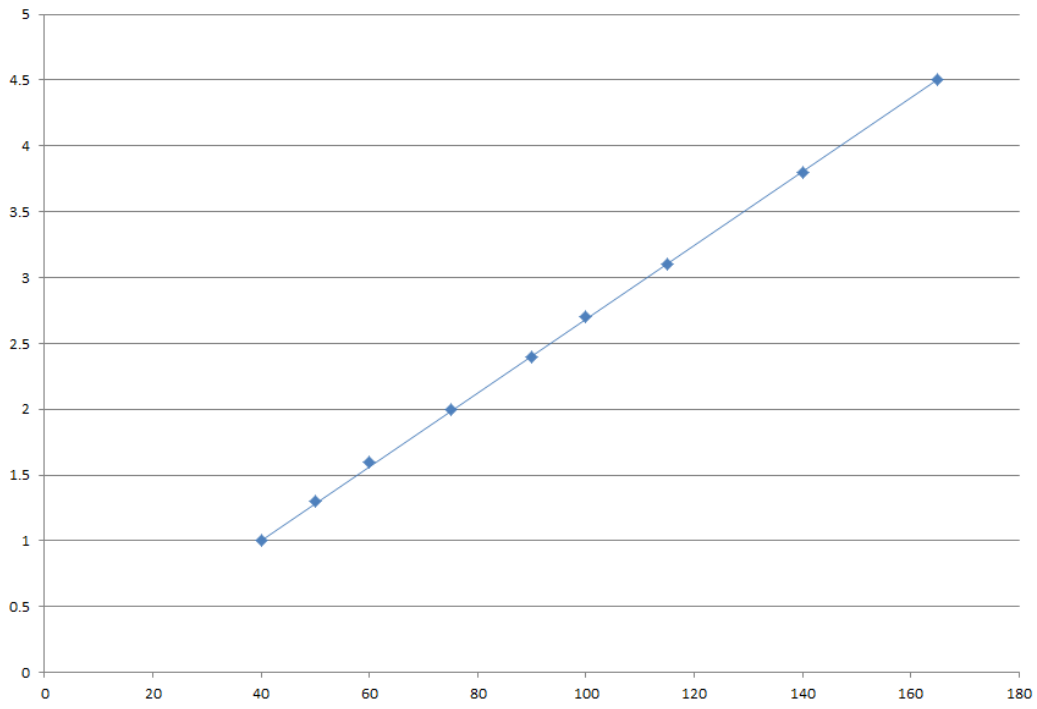



### A.6.3 Bostik FP 340 Pipe Wrap penetration seal for insulated metal pipes, in 2x Bostik FP 320 Fire Batt 1-S, in flexible or rigid walls

**Penetration Seal:** LS (Local Sustained) or CS (Continuous Sustained) insulated metallic and composite pipes (single) fitted at any position within the aperture, with 50 mm Bostik FP 320 Fire Batt 1-S to both sides of the wall. Bostik FP 340 Pipe Wraps are required to be fitted around the pipe to both sides of the seal.

Construction details:

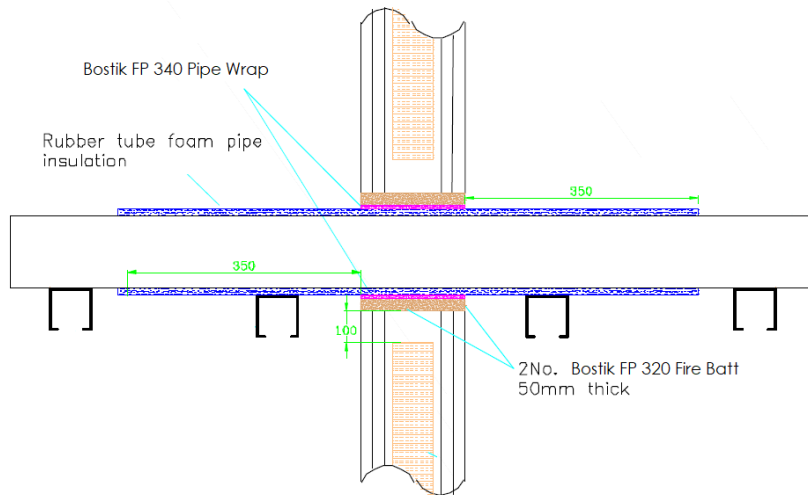

#### A.6.3.1

Services	Wrap	Insulation	Classification
Copper pipe			
12 mm diameter/1 mm wall	50 x 3.6 mm Bostik FP 340 Pipe Wrap fitted to both sides of the seal	9 mm Elastomeric insulation minimum class B-s3,d0 or PE Foam insulation	EI 120 C/C
12-54 mm diameter/1-1.2 mm wall		9-13 mm Elastomeric insulation minimum class B-s3,d0 or PE Foam insulation	E 120 C/C, EI 90 C/C
12-54 mm diameter/1-1.2 mm wall		13-25 mm Elastomeric insulation minimum class B-s3,d0 or PE Foam insulation	E 120 C/C, EI 60 C/C
Geberit Mepla MLC (PE-Xb/Aluminium/PE-HD pipe)*			
16 mm diameter/2.25 mm wall	50 x 3.6 mm Bostik FP 340 Pipe Wrap fitted to both sides of the seal	9-25 mm Elastomeric insulation minimum class B-s3,d0 or PE Foam insulation	EI 120 C/C
20 mm diameter/2.5 mm wall			
26 mm diameter/3 mm wall			
32 mm diameter/3 mm wall			
40 mm diameter/3.5 mm wall			
50 mm diameter/4 mm wall			
63 mm diameter/4.5 mm wall			
75 mm diameter/4.7 mm wall			

**A.6.4 Bostik FP 340 Pipe Wrap penetration seal for insulated metal pipes, in 2x Bostik FP 320 Fire Batt 1-S, in flexible or rigid walls**

**P Penetration Seal:** Combustible pipes (single) fitted central within the aperture, with Bostik FP 320 Fire Batt 1-S to both sides of the wall. Bostik FP 340 Pipe Wraps are required to be fitted around the pipe.

Construction details:

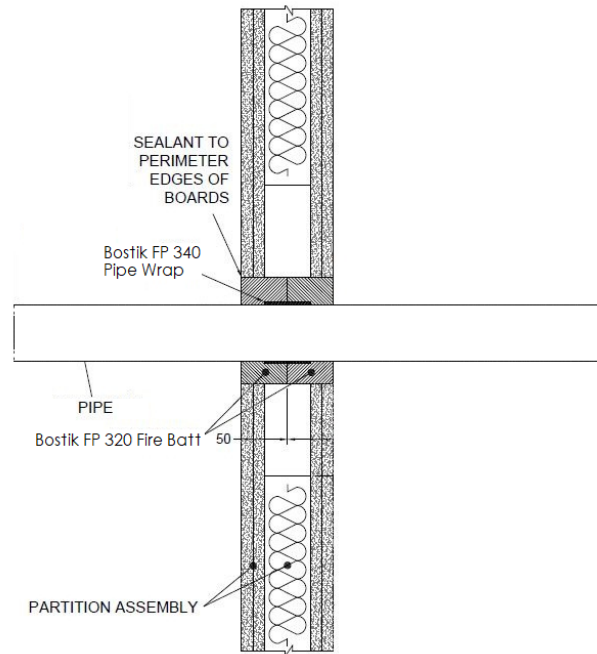

**A.6.4.1**

Services	Pipe Wrap	Classification
PVC-U pipe according to EN 1329-1, EN 1452-1 and EN 1453-1 315 mm $\varnothing$ /9.2 mm wall	Bostik FP 340 Pipe Wrap 75 x 18 mm fitted centrally around the pipe	EI 45 C/C

### A.6.5 Bostik FP 340 Pipe Wrap penetration seal for plastic pipes, in 2x Bostik FP 320 Fire Batt 1-S, in flexible or rigid walls

**Penetration Seal:** Combustible pipes sealed with Bostik FP 340 Pipe Wrap, to both sides of the wall. Minimum separation between penetration seals and seal edges of 30 mm. (Configuration 1 & 2).

#### Construction details:

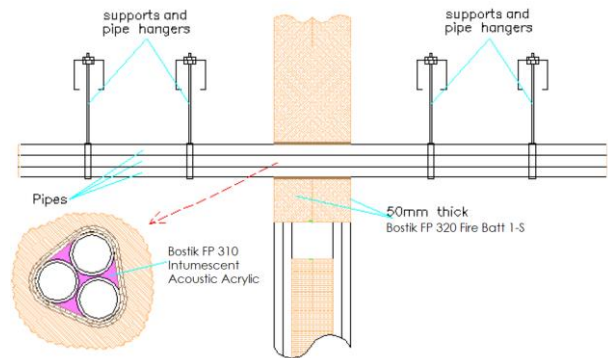
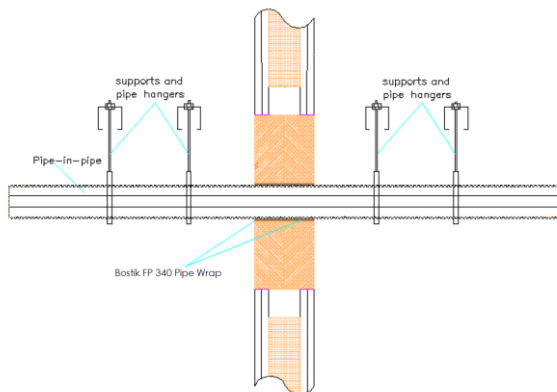
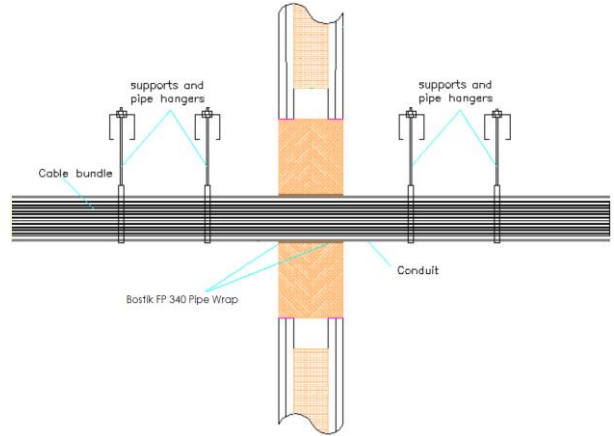
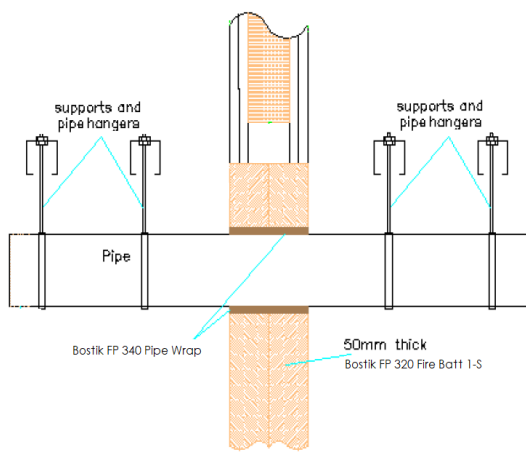

#### Configuration 1

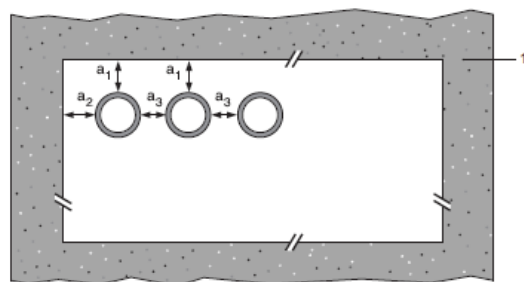

#### Configuration 2

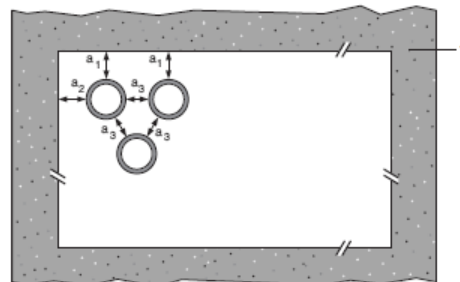

#### Key

- 1 Supporting construction
- a1 Pipe / top edge of seal separation
- a2 Pipe / side edge of seal separation
- a3 Pipe / pipe separation

### A.6.5.1

Services	Wraps (both sides)	Permitted configuration for seal separation	Classification
PVC-U pipe according to EN 1329-1, EN 1452-2 and EN 1453-1 and PVC-C according to EN 1566-1			
Diameter up to 40 mm, wall thickness 1.9 – 3.0 mm	50 x 1.8 mm (1 layer)	1 & 2 between PVC-U/PVC-C, PE/ABS/SAN+PVC and PP pipes in any combination	EI 120 U/U, EI 120 C/U, EI 120 U/C, EI 120 C/C
Diameter up to 110 mm, wall thickness 2.7 - 6.6 mm	50 x 3.6 mm (2 x 1.8 layer)		E 120 U/C, E 120 C/C EI 90 U/C, EI 90 C/C
Diameter up to 125 mm, wall thickness 3.7 – 7.4 mm	50 x 5.4 mm (3 x 1.8 layer)		
Diameter up to 160 mm, wall thickness 9.5 mm *	50 x 7.2 mm (4 x 1.8 layer)		
Diameter up to 315 mm, wall thickness 7.7-12.1 mm*	50 x 18 mm (10 x 1.8 layers)	n/a	EI 90 C/C
Diameter up to 400 mm, wall thickness 9.8-15.3 mm*	50 x 28.8 mm (16 x 1.8 layers)	n/a	EI 90 C/C
Diameter up to 110 mm, wall thickness 2.7–6.6 mm, fully or partially filled conduits with cables up to 14 mm diameter	50 x 3.6 mm (2 x 1.8 layers)	1 & 2	E 120 U/C, EI 90 U/C
PE pipe according to EN 1519-1, EN 12201-2 and EN 12006-1, ABS according to EN 1455-1 and pipes made from SAN+PVC according to EN 1565-1			
Diameter up to 40 mm, wall thickness 2.4 – 3.7 mm	50 x 1.8 mm (1 layer)	1 & 2 between PVC-U/PVC-C, PE/ABS/SAN+PVC and PP pipes in any combination	EI 120 U/U, EI 120 C/U, EI 120 U/C, EI 120 C/C
Diameter up to 110 mm, wall thickness 4.2 - 10 mm	50 x 3.6 mm (2 x 1.8 layer)		E 120 U/C, E 120 C/C EI 90 U/C, EI 90 C/C
Diameter up to 125 mm, wall thickness 4.8 – 12 mm	50 x 5.4 mm (3 x 1.8 layer)		
Diameter up to 160 mm, wall thickness 14.6 mm	50 x 7.2 mm (4 x 1.8 layer)		
Diameter up to 110 mm, wall thickness 4.2–10 mm, fully or partially filled conduits with cables up to 14 mm diameter	50 x 3.6 mm (2 x 1.8 layers)	1 & 2	E 120 U/C, EI 90 U/C
PP pipe according to EN 1852-1: 2009			
Diameter up to 40 mm, wall thickness 1.8 – 5.5 mm	50 x 1.8 mm (1 layer)	1 & 2 between PVC-U/PVC-C, PE/ABS/SAN+PVC and PP pipes in any combination	EI 120 U/U, EI 120 C/U, EI 120 U/C, EI 120 C/C
Diameter up to 110 mm, wall thickness 2.7 - 15.1 mm	50 x 3.6 mm (2 x 1.8 layer)		EI 90 U/U, EI 90 C/U, EI 90 U/C, EI 90 C/C
Diameter up to 125 mm, wall thickness 3.1 – 17.1 mm	50 x 5.4 mm (3 x 1.8 layer)		
Diameter up to 160 mm, wall thickness 21.9 mm	50 x 7.2 mm (4 x 1.8 layer)		
Diameter up to 110 mm, wall thickness 2.7–15.1 mm, fully or partially filled conduits with cables up to 14 mm diameter	50 x 3.6 mm (2 x 1.8 layers)	1 & 2	E 120 U/C, EI 90 U/C
Uponor Wirsbo PEX pipe in pipe system according to ISO 15875			
Diameter up to 54 mm/4.0 mm wall thickness (outer pipe), 28 mm diameter/0.4 mm wall thickness (inner pipe)	50 x 3.6 mm (2 x 1.8 layers)	1 & 2	EI 120 C/C

Uponor Wirsbo PEX double pipe in pipe system			
Diameter up to 25 mm pipes, wall thickness 0.6 mm, in bundles up to 50 mm	50 x 3.6 mm (2 x 1.8 layers)	1 & 2	EI 90 C/C
BluePower Multilayer pipe according to EN 1451-1			
32-50 mm diameter/1.8 mm wall thickness*	50 x 3.6 mm (2 x 1.8 layers)	1 & 2	EI 90 U/U
75-110 mm diameter/3.4 mm wall thickness*	50 x 3.6 mm (2 x 1.8 layers)	1 & 2	EI 90 C/U
Rehau Raupiano Plus PP-DD according to DIN 4102			
40-50 mm diameter/1.8-2.7 mm wall thickness*	50 x 3.6 mm (2 x 1.8 layers)	1 & 2	EI 120 U/U
75-110 mm diameter/2.7 mm wall thickness*	50 x 3.6 mm (2 x 1.8 layers)	1 & 2	EI 120 U/C
125 mm diameter/3.9 mm wall thickness	50 x 7.2 mm (4 x 1.8 layers)	1 & 2	EI 120 U/C
160 mm diameter/3.9 mm wall thickness	50 x 10.8 mm (6 x 1.8 layers)	1 & 2	EI 120 U/C
Polo-Kal NG Poloplast PP-MV according to DIN 4102			
32-50 mm diameter/2.0-3.4 mm wall thickness*	50 x 3.6 mm (2 x 1.8 layers)	1 & 2	EI 120 U/U
75-110 mm diameter/3.4 mm wall thickness*	50 x 3.6 mm (2 x 1.8 layers)	1 & 2	EI 120 U/C
125 mm diameter/3.9 mm wall thickness	50 x 7.2 mm (4 x 1.8 layers)	1 & 2	EI 120 U/C
160 mm diameter/4.9 mm wall thickness	50 x 10.8 mm (6 x 1.8 layers)	1 & 2	EI 120 U/C
Aquatherm Green SDR9 MF PP-RP according to ISO 21003			
32 mm diameter/3.0 mm wall thickness	50 x 1.8 mm (1 x 1.8 layer)	1 & 2	E 120 C/C, EI 90 C/C
40-50 mm diameter/5.6-12.3 mm wall thickness*	50 x 3.6 mm (2 x 1.8 layers)	1 & 2	E 120 C/C, EI 90 C/C
63-110 mm diameter/12.3 mm wall thickness*	50 x 3.6 mm (2 x 1.8 layers)	1 & 2	E 120 C/C, EI 90 C/C
Wavin SiTech + PP-M B according to EN 13501-1			
32-50 mm diameter/1.8-3.4 mm wall thickness*	50 x 3.6 mm (2 x 1.8 layers)	1 & 2	E 120 U/U, EI 90 U/U
75-110 mm diameter/3.4 mm wall thickness*	50 x 3.6 mm (2 x 1.8 layers)	1 & 2	E 120 U/C, EI 60 U/C
Gilbert Silent PP according to DIN 4102			
32-50 mm diameter/1.8-3.4 mm wall thickness*	50 x 3.6 mm (2 x 1.8 layers)	1 & 2	EI 120 U/U
75-110 mm diameter/3.4 mm wall thickness*	50 x 3.6 mm (2 x 1.8 layers)	1 & 2	EI 120 U/C

\*See below graph for interpolation pipe sizes

### PVC-U Pipes - E 90 C/C, EI 60 C/C

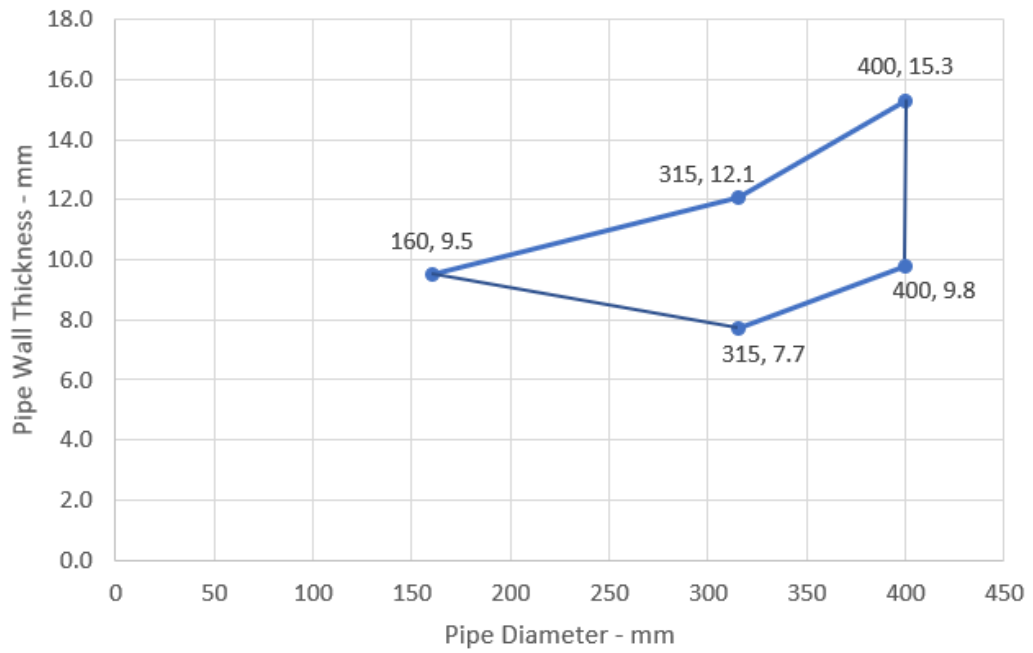

### BluePower - EI 90 C/U

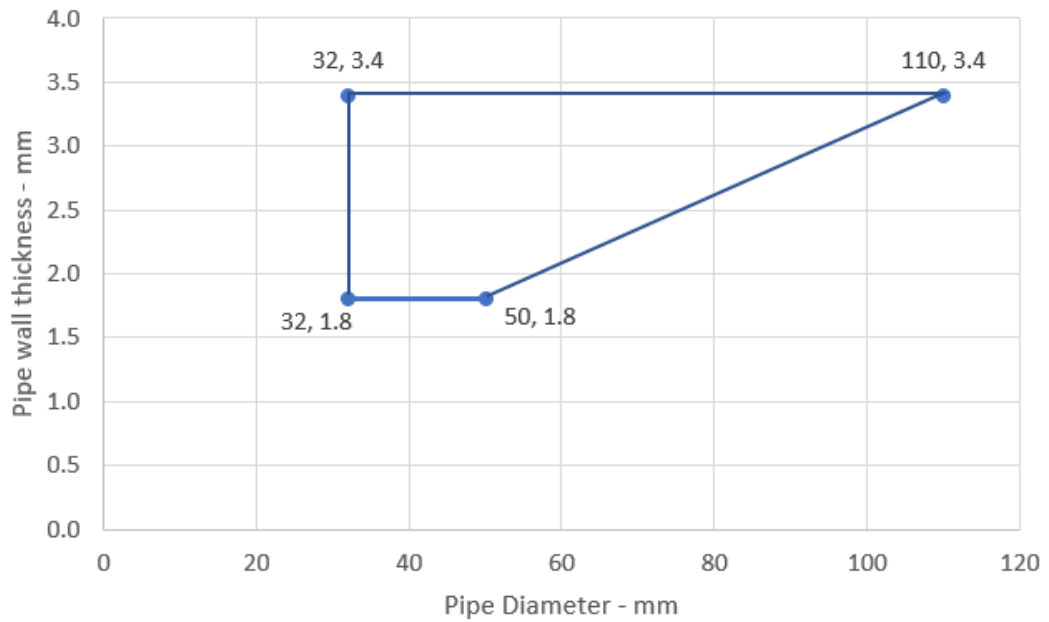

### Rehau Raupiano Plus -EI 120 U/C

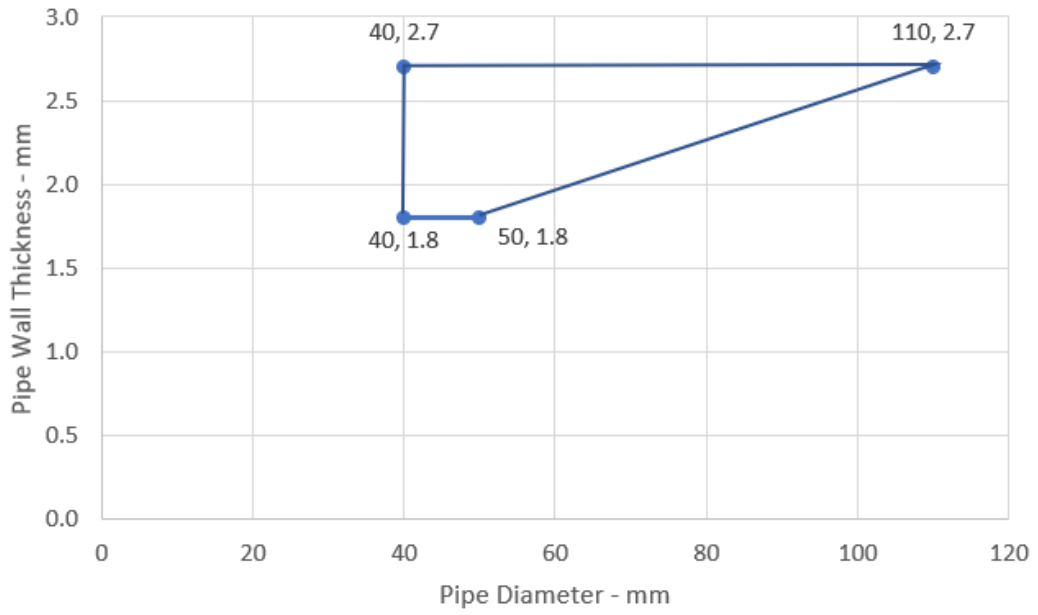

### Polo-Kal NG - EI 120 U/C

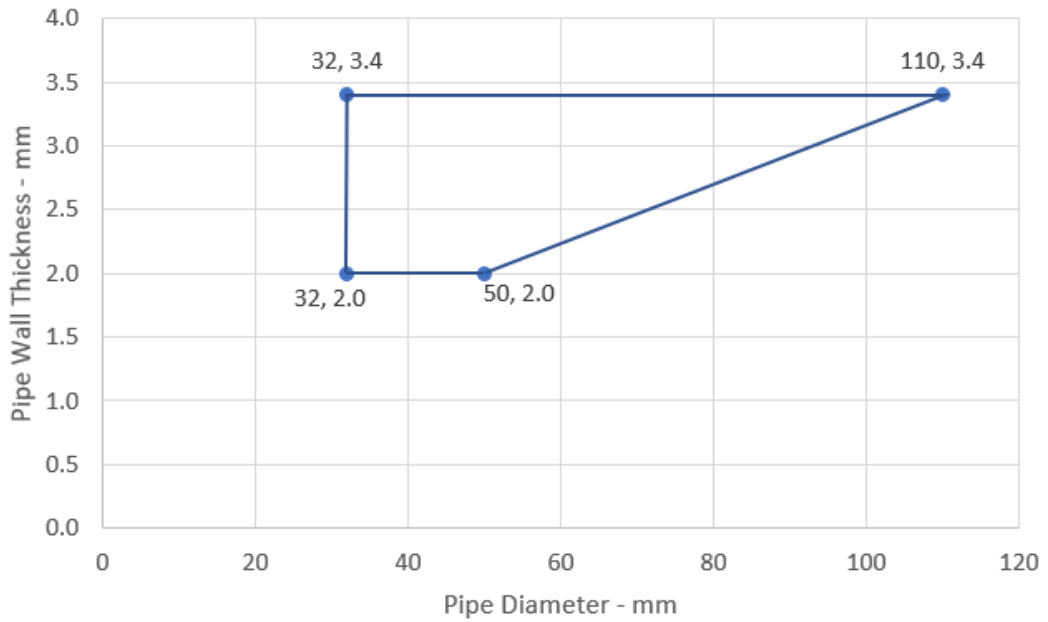

### Aquatherm Green - E 120 C/C, EI 90 C/C

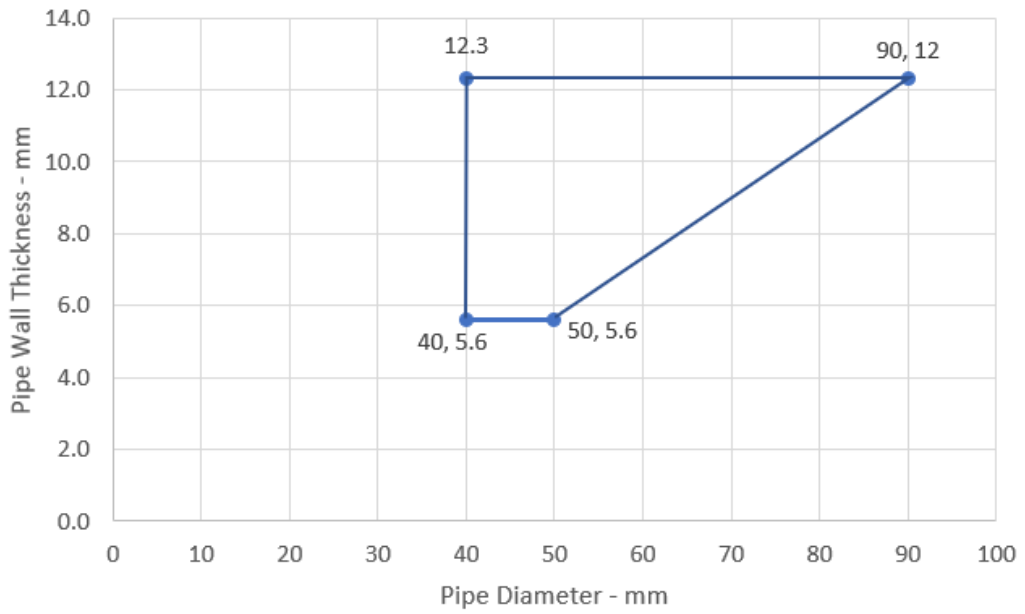

### Wavin SiTech Pipes - E120 C/C, EI 60 C/C

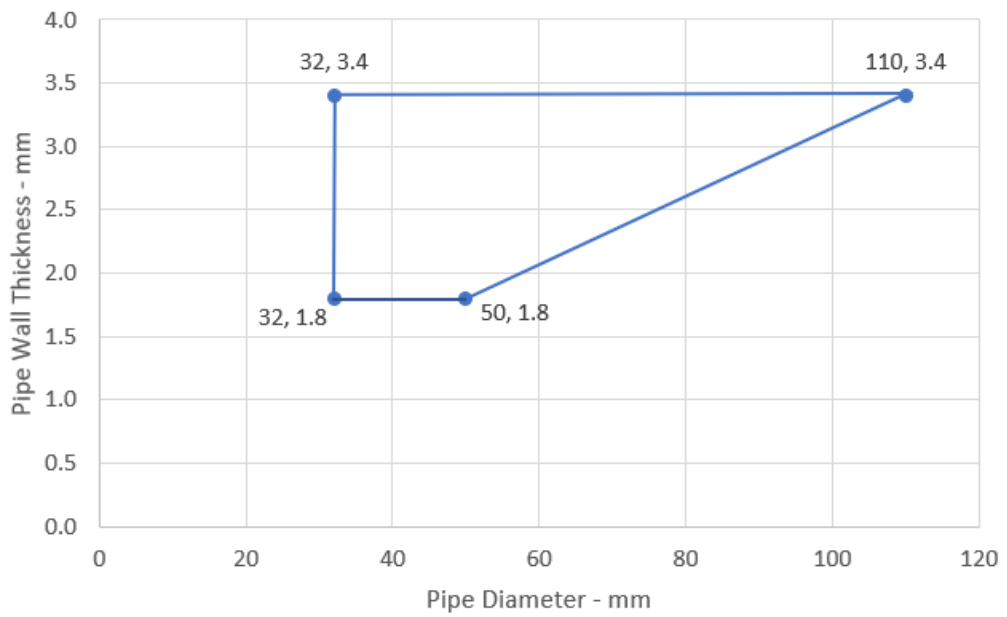



### Gilbert Silent PP - EI 120 U/C

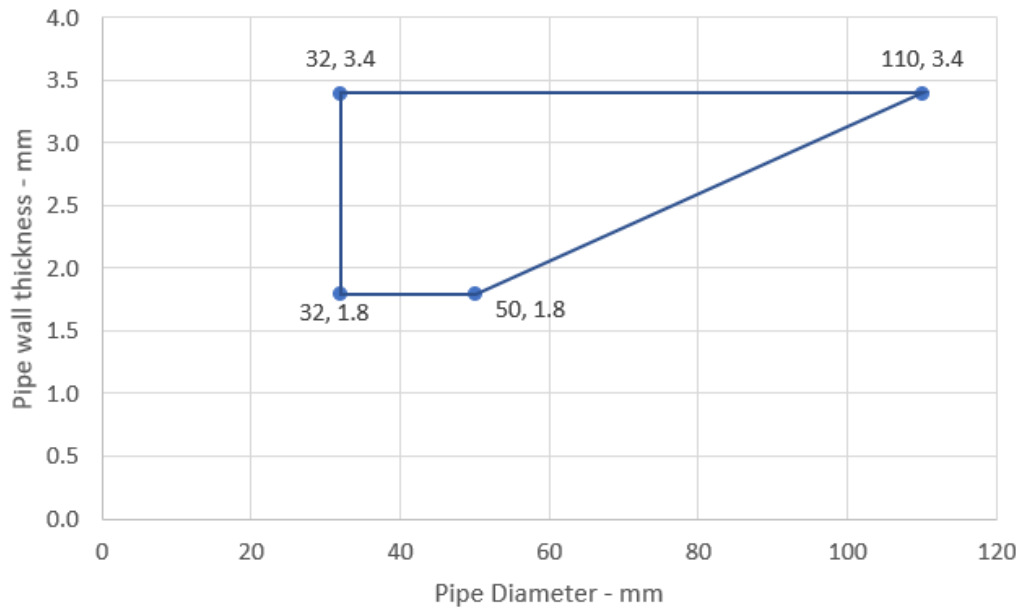

**A.6.6 Penetration seal in Bostik FP 370 Fireseal Mortar seals, in flexible\* and rigid walls minimum 100 mm thick**

**Penetration Seal:** Combustible pipes sealed with Bostik FP 340 Pipe Wrap, installed into Bostik FP 370 Fireseal Mortar seals. Minimum separation between penetration seals and seal edges of 30 mm.

Construction details:

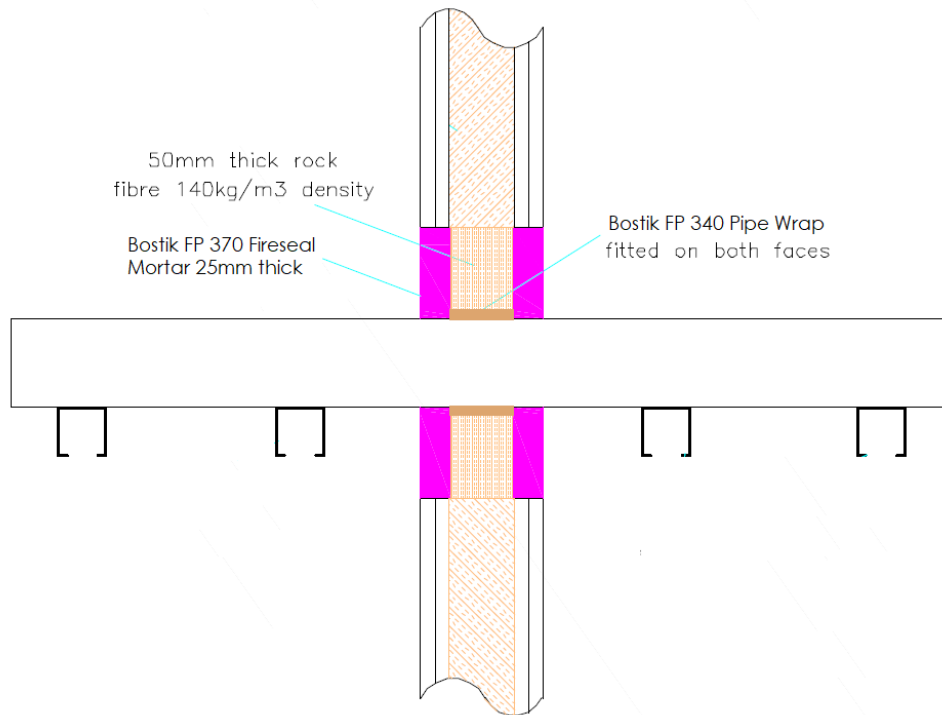

**Configuration 1**

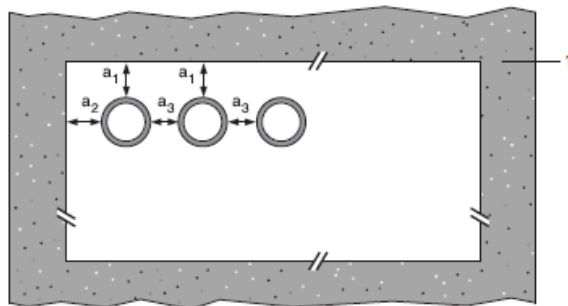

**Configuration 2**

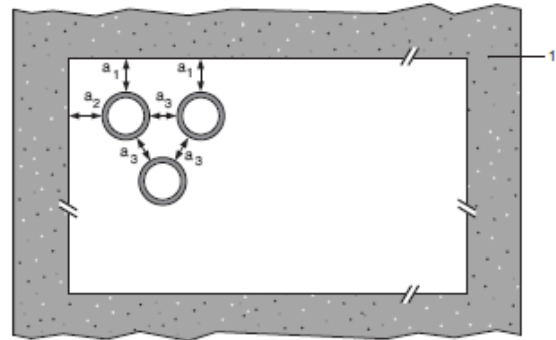

**Key**

- 1 Supporting construction
- a1 Pipe / top edge of seal separation
- a2 Pipe / side edge of seal separation
- a3 Pipe / pipe separation

**\* Partition wall must incorporate a full fill core insulation of Stonewool (35kg/m<sup>3</sup> density)**

### A.6.6.1

Services	Wraps (both sides)	Permitted configuration for seal separation	Classification
PVC-U pipe according to EN 1329-1, EN 1452-2 and EN 1453-1 and PVC-C according to EN 1566-1			
Diameter up to 40 mm, wall thickness 3.0 – 4.3 mm	50 x 1.8 mm (1 layer)	1 & 2 between PVC-U/PVC-C, PE/ABS/SAN+PVC and PP pipes in any combination	E 120 U/C, E 120 C/U, EI 60 U/C, EI 60 C/C
Diameter up to 110 mm, wall thickness 2.7 - 6.6 mm	50 x 3.6 mm (2 x 1.8 layer)		E 120 U/C, E 120 C/C EI 90 U/C, EI 90 C/C
Diameter up to 125 mm, wall thickness 3.7 – 7.4 mm	50 x 5.4 mm (3 x 1.8 layer)		EI 120 U/C, EI 120 C/C
Diameter up to 160 mm, wall thickness 3.2 - 9.5 mm	50 x 7.2 mm (4 x 1.8 layer)		EI 60 U/C, EI 60 C/C
PE pipe according to EN 1519-1, EN 12201-2 and EN 12006-1, ABS according to EN 1455-1 and pipes made from SAN+PVC according to EN 1565-1			
Diameter up to 40 mm, wall thickness 3.2 – 3.7 mm	50 x 1.8 mm (1 layer)	1 & 2 between PVC-U/PVC-C, PE/ABS/SAN+PVC and PP pipes in any combination	EI 120 U/C, EI 120 C/C
Diameter up to 110 mm, wall thickness 4.2 - 10 mm	50 x 3.6 mm (2 x 1.8 layer)		EI 60 U/C, EI 60 C/C
Diameter up to 125 mm, wall thickness 12 mm	50 x 5.4 mm (3 x 1.8 layer)		EI 120 U/C, EI 120 C/C
Diameter up to 160 mm, wall thickness 4.9 – 12.0 mm	50 x 7.2 mm (4 x 1.8 layer)		E 120 U/C, E 120 C/C
Diameter up to 160 mm, wall thickness 12.0 mm			EI 90 U/C, EI 90 C/C
PP pipe according to EN 1852-1: 2009			
Diameter up to 40 mm, wall thickness 4.0 – 5.5 mm	50 x 1.8 mm (1 layer)	1 & 2 between PVC-U/PVC-C, PE/ABS/SAN+PVC and PP pipes in any combination	EI 120 U/C, EI 120 C/C
Diameter up to 110 mm, wall thickness 6.6 mm	50 x 3.6 mm (2 x 1.8 layer)		E 120 U/C, E 120 C/C EI 90 U/C, EI 90 C/C
Diameter up to 125 mm, wall thickness 17.1 mm	50 x 5.4 mm (3 x 1.8 layer)		E 120 U/C, E 120 C/C EI 90 U/C, EI 90 C/C
Diameter up to 160 mm, wall thickness 4.0 - 21.9 mm	50 x 7.2 mm (4 x 1.8 layer)		E 120 U/C, E 120 C/C
Diameter up to 160 mm, wall thickness 21.9 mm			EI 60 U/C, EI 60 C/C