



UL INTERNATIONAL (UK) LTD  
Kingsland Business Park,  
Unit 1-3 Horizon,  
Wade Rd,  
Basingstoke RG24 8AH,  
United Kingdom.



designated according to Article 29 of the Regulation (EU) No 305/2011 and member of EOTA (European Organisation for Technical Assessment, [www.eota.eu](http://www.eota.eu))

## European Technical Assessment

## ETA 19/0392 of 23/07/2020

**Technical Assessment Body issuing the ETA and designated according to Article 29 of the Regulation (EU) No 305/2011: UL International (UK) Ltd**

**Trade name of the construction product**

Bostik FP 320 Fire Batt

**Product family to which the construction product belongs**

Fire Stopping and Sealing Product:  
• Penetration Seals

**Manufacturer**

Bostik BV  
Denariusstraat 11  
4903 RC Oosterhout  
The Netherlands

**Manufacturing plant(s)**

A/003

**This European Technical Assessment contains**

51 pages including 1 Annex which forms an integral part of this assessment.

**This European Technical Assessment is issued in accordance with regulation (EU) No 305/2011, on the basis of**

EAD 350454-00-1104, September 2017

**This version replaces**

ETA 19/0392 issued on 12/07/2019

Translations of this European Technical Assessment in other languages shall fully correspond to the original issued document and should be identified as such.

Communication of this European Technical Assessment, including transmission by electronic means, shall be in full. However, partial reproduction may be made, with the written consent of the issuing Technical Assessment Body. Any partial reproduction has to be identified as such.

## Table of Contents

<b>I.</b>	<b>SPECIFIC PARTS OF THE EUROPEAN TECHNICAL ASSESSMENT</b>	<b>3</b>
1	Technical description of the product	3
2	Specification of the intended uses of the product in accordance with the applicable European Assessment Document (Hereinafter EAD): EAD 350454-00-1104	3
3	Performance of the product and references to the methods used for its assessment	5
4	ASSESSMENT AND VERIFICATION OF CONSTANCY OF PERFORMANCE (HEREINAFTER AVCP) SYSTEM APPLIED, WITH REFERENCE TO ITS LEGAL BASE	6
5	Technical details necessary for the implementation of the AVCP system, as provided for in the applicable EAD	6
6	Issued on:	7
	<b>ANNEX A – Resistance to Fire Classification – Bostik FP 320 Fire Batt</b>	<b>8</b>
A.1	Rigid wall constructions according to 2. 2) with wall thickness of minimum 150 mm	8
A.1.1	Cable penetration seal with 2x 60 mm thick Bostik FP 320 Fire Batt 2-S	8
A.1.2	Cable penetration seal with 1x 60 mm thick Bostik FP 320 Fire Batt 2-S	9
A.1.3	Pipe penetration seal with 2x 60 mm thick Bostik FP 320 Fire Batt 2-S	10
A.1.4	Pipe penetration seal with 2x Bostik FP 320 Fire Batt 2-S	12
A.1.5	Pipe penetration seal with 1x 60 mm thick Bostik FP 320 Fire Batt 2-S	14
A.1.5	Pipe penetration seal with 1x Bostik FP 320 Fire Batt 2-S	17
A.1.6	Bostik FP 320 Fire Batt 60 mm 2-S penetration seal (protruding) blank and with cables, in rigid wall min. 150 mm thick	18
A.1.7	Bostik FP 320 Fire Batt 60 mm 2-S penetration seal (pattress) blank and with cables, in rigid wall min. 150 mm thick	19
A.1.8	Penetration seal with 2x Bostik FP 320 Fire Batt 2-S	20
A.2	Rigid floor constructions according to 2. 2) with floor thickness of minimum 150 mm	21
A.2.1	Cable penetration seal with 2x Bostik FP 320 Fire Batt 2-S	21
A.2.2	Cable penetration seal with 1x Bostik FP 320 Fire Batt 2-S	22
A.2.3	Pipe penetration seal with 2x Bostik FP 320 Fire Batt 2-S	23
A.2.4	Pipe penetration seal with 1x Bostik FP 320 Fire Batt 2-S	25
A.2.5	Pipe penetration seal with 1x Bostik FP 320 Fire Batt 2-S	28
A.2.6	Pipe penetration seal with 1x Bostik FP 320 Fire Batt 2-S	29
A.2.7	Pipe penetration seal with 2x Bostik FP 320 Fire Batt 2-S	30
A.2.8	Pipe penetration seal with 2x Bostik FP 320 Fire Batt 2-S (back to back)	31
A.3	Flexible wall constructions according to 2. 2) with wall thickness of minimum 75 mm and 1 x layers of 12.5 mm Type F Gypsum board on both faces	33
A.3.1	Cable penetration seal with 2x Bostik FP 320 Fire Batt 30 1-S	33
A.4	Flexible wall constructions according to 2. 2) with wall thickness of minimum 100 mm and 2 x layers of 12.5 mm Type F Gypsum board on both faces	35
A.4.1	Cable penetration seal with 2x Bostik FP 320 Fire Batt 1-S	35
A.4.2	Pipe penetration seal with 2x Bostik FP 320 Fire Batt 1-S	36
A.4.3	Pipe penetration seal with 2x Bostik FP 320 Fire Batt 1-S	39
A.4.4	Pipe penetration seal with 2x Bostik FP 320 Fire Batt 1-S	41
A.4.5	Pipe penetration seal with 2x Bostik FP 320 Fire Batt 1-S	43
A.4.6	Pipe penetration seal with 2x Bostik FP 320 Fire Batt 1-S	46
A.4.7	Plastic pipe penetration seal with 2x Bostik FP 320 Fire Batt 1-S	48
A.4.8	Cable penetration seal with 1x Bostik FP 320 Fire Batt 50 2-S in framed aperture	49

## I. SPECIFIC PARTS OF THE EUROPEAN TECHNICAL ASSESSMENT

### 1 Technical description of the product

- 1) Bostik FP 320 Fire Batt is a coated mineral wool board used to reinstate the fire resistance performance of wall and floor constructions where they have been provided with apertures for the penetration of single or multiple services.
- 2) The Bostik FP 320 Fire Batt is supplied coated on one face, referenced 1-S, or on both faces, referenced 2-S. The board or boards are then cut to allow the penetration of the required services, before being inserted into the aperture in the wall.
- 3) Bostik FP 340 Pipe Wraps are required to be used in conjunction with Bostik FP 320 Fire Batt depending upon the required application and classification (see Annex B). Bostik FP 340 Pipe Wraps are the subject of a separate ETA which is not declared in the document for confidentiality reasons.
- 4) The applicant has submitted a written declaration that Bostik FP 320 Fire Batt does not contain substances which have to be classified as dangerous according to Directive 67/548/EEC and Regulation (EC) No 1272/2008 and listed in the "Indicative list on dangerous substances" of the EGDS - taking into account the installation conditions of the construction product and the release scenarios resulting from there.

In addition to the specific clauses relating to dangerous substances contained in this European technical Assessment, there may be other requirements applicable to the products falling within its scope (e.g. transposed European legislation and national laws, regulations and administrative provisions). In order to meet the provisions of the Construction Products Regulation, these requirements need also to be complied with, when and where they apply.

### 2 Specification of the intended uses of the product in accordance with the applicable European Assessment Document (Hereinafter EAD): EAD 350454-00-1104

Detailed information and data is given in Annex A.

- 1) The intended use of Bostik FP 320 Fire Batt is to reinstate the fire resistance performance of flexible wall, rigid wall and floor constructions where they are penetrated by various cables, metallic pipes, composite pipes and plastic pipes.
- 2) The specific elements of construction that the system Bostik FP 320 Fire Batt may be used to provide a penetration seal in, are as follows:
  - a. Flexible walls: The wall must have a minimum thickness of 75 mm and comprise steel studs lined on both faces with minimum 1 layers of 12.5 mm thick boards. Apertures are not required to be lined.
  - b. Rigid walls: The wall must have a minimum thickness of 75 mm and comprise concrete, aerated concrete or masonry, with a minimum density of 650 kg/m<sup>3</sup>.
  - c. Rigid floors: The floor must have a minimum thickness of 150 mm and comprise aerated concrete or concrete with a minimum density of 650 kg/m<sup>3</sup>.

The supporting construction must be classified in accordance with EN 13501-2 for the required fire resistance period.

- 3) The System Bostik FP 320 Fire Batt may be used to provide a penetration seal with cables, cable trays, metallic pipes, composite pipes and plastic pipes, with and without insulation, with mixed services within the same seal/aperture (for details see Annex A).
- 4) The total amount of cross sections of services (including insulation) should not exceed 60% of the penetration area.
- 5) The system Bostik FP 320 Fire Batt may be used to seal apertures in the separating element of unlimited width by 1200mm high in a wall (uninterrupted separating studs will be required at 2400 mm centres or less in flexible walls), and 2400mm by 1200 mm in a floor. The minimum permitted separation between adjacent seals/apertures is 200mm. Services should be a minimum of 25mm from seal edges. Services within the system Bostik FP 320 Fire Batt seal do not require a minimum separation, except pipes where pipe insulation penetrates the seal and plastic pipe penetrations which should be a minimum of 30 mm from other services in the aperture.
- 6) Services in floors shall be supported at 250mm and 400mm from the top face. Services in walls shall be supported at 270mm and 470mm from both faces of the wall.
- 7) The provisions made in this European Technical Assessment are based on an assumed working life of the Bostik FP 320 Fire Batt of 25 years, provided that the conditions laid down in the product datasheet for the packaging/transport/ storage/installation/use/repair are met. The indications given on the working life cannot be interpreted as a guarantee given by the producer, but are to be regarded only as a means for choosing the right products in relation to the expected economically reasonable working life of the works.
- 8) Type Y<sub>1</sub>: intended for use at temperatures below 0°C with exposure to UV but no exposure to rain. Includes lower classes Y<sub>2</sub>, Z<sub>1</sub>, Z<sub>2</sub>.

### 3 Performance of the product and references to the methods used for its assessment

Product-type: Sealant		Intended use: Penetration Seal
Assessment method	Essential characteristic	Product Performance
<b>BWR 2 Safety in case of fire</b>		
EN 13501-1	Reaction to fire	Class F (untested)
EN 13501-2	Resistance to fire	Annex A
<b>BWR 3 Hygiene, health and environment</b>		
EN 1026	Air permeability	No performance determined
EAD 350454-00-1104, Annex C	Water permeability	No performance determined
Declaration of manufacturer & EN 16516	Content, emission and/or release of dangerous substances	Declaration of manufacturer
<b>BWR 4 Safety in use</b>		
EOTA TR 001:2003	Mechanical resistance and stability	No performance determined
EOTA TR 001:2003	Resistance to impact/movement	No performance determined
EOTA TR 001:2003	Adhesion	No performance determined
EAD 350454-00-1104, Clause 2.2.9	Durability	Y <sub>1</sub>
<b>BWR 5 Protection against noise</b>		
EN 10140-1,2,4,5/ EN ISO 717-1	Airborne sound insulation	No performance determined
<b>BWR 6 Energy economy and heat retention</b>		
EN 12664, EN 12667, EN 12939, EN ISO 8990, EN ISO 6946, EN ISO 14683, EN ISO 10211, EN ISO 10456	Thermal properties	No performance determined
EN ISO 12572, EN 12086, EN ISO 10456	Water vapour permeability	No performance determined

**4 ASSESSMENT AND VERIFICATION OF CONSTANCY OF PERFORMANCE (HEREINAFTER AVCP) SYSTEM APPLIED, WITH REFERENCE TO ITS LEGAL BASE**

According to the decision 1999/454/EC – Commission Decision of date 22nd June 1999 on the procedure for attesting the conformity of construction products pursuant to Article 20(2) of Council Directive 89/106/EEC as regards fire stopping, fire sealing and fire protective products, published in the Official Journal of the European Union (OJEU) L178/52 of 14/07/1999, see <https://eur-lex.europa.eu/oj/direct-access.html> of the European Commission<sup>1</sup>, as amended, the system(s) of assessment and verification of constancy of performance (see Annex V to Regulation (EU) No 305/2011) given in the following table(s) applies (apply).

<b>Product(s)</b>	<b>Intended use(s)</b>	<b>Level(s) or class(es)</b>	<b>System(s)</b>
Fire stopping and Fire Sealing Products	For fire compartmentation and/or fire protection or fire performance	Any	1

**5 Technical details necessary for the implementation of the AVCP system, as provided for in the applicable EAD**

Tasks of the manufacturer:

Factory production control

The manufacturer shall exercise permanent internal control of production. All the elements, requirements and provisions adopted by the manufacturer shall be documented in a systematic manner in the form of written policies and procedures, including records of results performed. This production control system shall ensure that the product is in conformity with this European technical Assessment.

The manufacturer may only use initial / raw / constituent materials stated in the technical documentation of this European Technical Assessment.

The factory production control shall be in accordance with the Control Plan of 4<sup>th</sup> June 2018 relating to the European technical assessment ETA 19/0392 issued on 23/07/2020 which is part of the technical documentation of this European technical approval. The "Control Plan" is laid down in the context of the factory production control system operated by the manufacturer and deposited at UL International (UK) Ltd.

The results of factory production control shall be recorded and evaluated in accordance with the provisions of the Control Plan.

---

<sup>1</sup> Official Journal of the European Communities L178/52 of 14/7/1999

Other tasks of the manufacturer

Additional information

The manufacturer shall provide a technical data sheet and an installation instruction with the following minimum information:

(a) Technical data sheet:

- Field of application:
- Building elements for which the penetration seal is suitable, type and properties of the building elements like minimum thickness, density, and - in case of lightweight constructions – the construction requirements.
- Limits in size, minimum thickness etc. of the penetration seal
- Construction of the penetration seal including the necessary components and additional products (e.g. backfilling material) with clear indication whether they are generic or specific.
- Services which the penetration seal is suitable, type and properties of the services like material, diameter, thickness etc. in case of pipes including insulation materials; necessary/allowed supports/fixings (e.g. cable trays)

(b) Installation instruction:

- Steps to be followed
- Procedure in case of retrofitting
- Stipulations on maintenance, repair and replacement

**6 Issued on:**

**23<sup>rd</sup> July 2020**

Report by:



D. Yates  
Senior Project Engineer  
Building and Life Safety Technologies

Reviewed by:



C. Johnson  
Staff Engineer  
Building and Life Safety Technologies

**For and on behalf of UL International (UK) Ltd.**

# ANNEX A – Resistance to Fire Classification – Bostik FP 320 Fire Batt

## A.1 Rigid wall constructions according to 2. 2) with wall thickness of minimum 150 mm

### A.1.1 Cable penetration seal with 2x 60 mm thick Bostik FP 320 Fire Batt 2-S

**Penetration Seal:** Cables fitted at any position within the aperture, with 60 mm Bostik FP 320 Fire Batt 2-S to both sides of the wall.

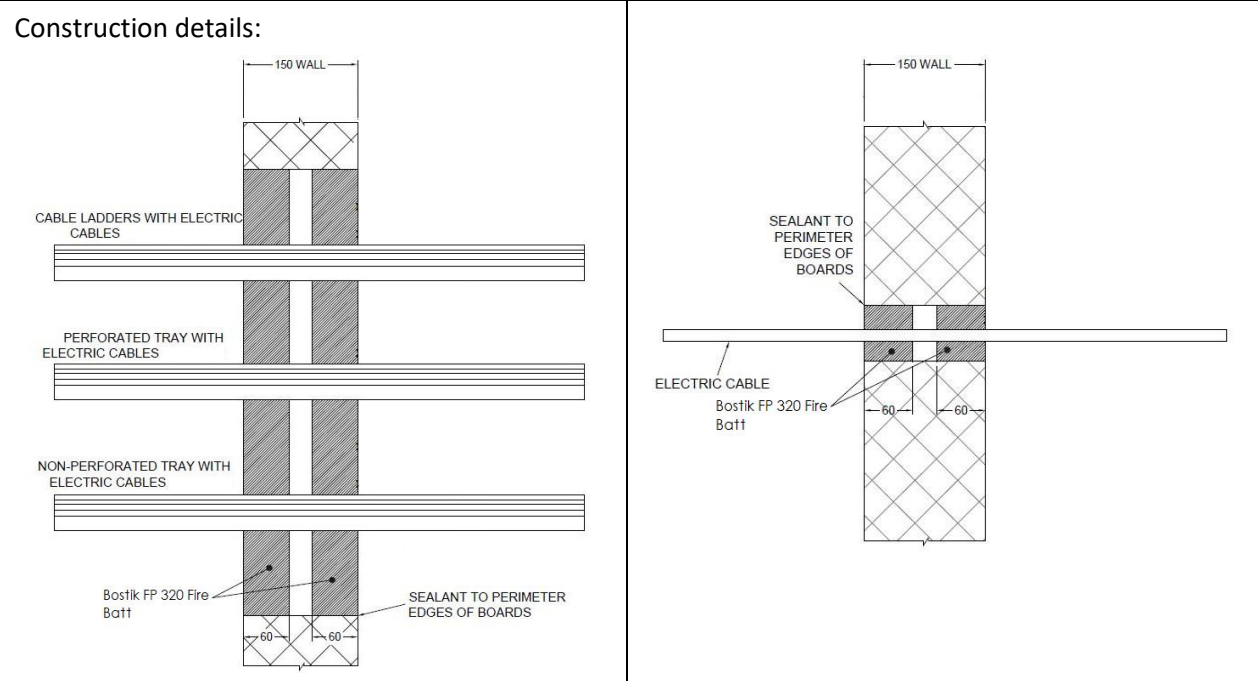

#### A.1.1.1 Double side penetration seal with cables

Services	Classification
None (blank), at max. 1200 x 1200 mm	EI 240
None (blank)	E 240, EI 180
Single electrical cables up to 21 mm $\varnothing$	
Single or bundled electrical cables up to 21 mm $\varnothing$ , with or without trays	E 240, EI 180
Electrical cables up to 80 mm $\varnothing$ (single, bundled and on trays)	E 180, EI 60
Cables up to 21mm $\varnothing$ in tied bundles up to 100mm $\varnothing$	E 180, EI 120
Steel cable trays & ladders	E 180, EI 60
PVC conduit up to 16 mm $\varnothing$	EI 180 C/U, EI 180 C/C



### A.1.2 Cable penetration seal with 1x 60 mm thick Bostik FP 320 Fire Batt 2-S

**Penetration Seal:** Cables (single) fitted at any position within the aperture, with Bostik FP 320 Fire Batt 2-S positioned to either face of the wall (or anywhere in between).

Construction details:

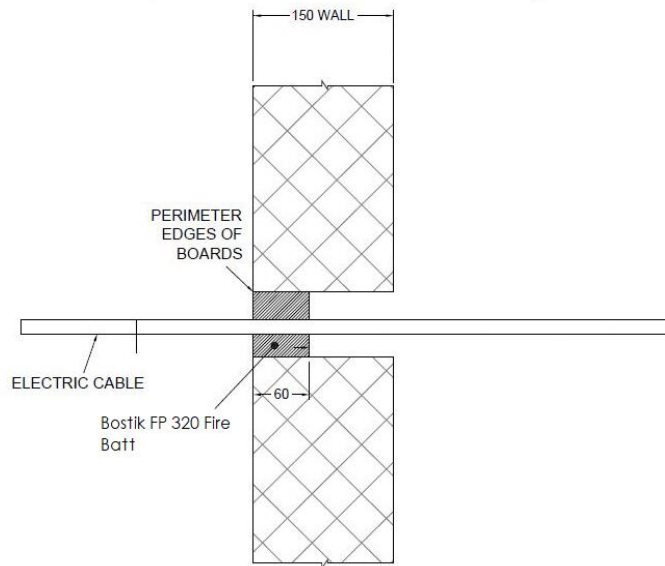

#### A.1.2.1 Single side penetration seal with cables

Services	Maximum aperture	Classification
None (blank)	As section 2. 5)	<b>E 240, EI 90</b>
Single electrical cables up to 21 mm $\varnothing$		
Single A1 cable = 5 x 1.5 mm <sup>2</sup> core HD603.3 electrical cable with PVC insulation, PVC sheath and 14 mm diameter	70 x 70 mm	<b>EI 240</b>
Single A2 cable = 5 x 1.5 mm <sup>2</sup> core HD22.4 electrical cable with EPR insulation, PO sheath and 11.2-14.4 mm diameter		
Single A3 cable = 5 x 1.5 mm <sup>2</sup> core HD604.5 electrical cable with XLPE insulation, EVA sheath and 13 mm diameter		

### A.1.3 Pipe penetration seal with 2x 60 mm thick Bostik FP 320 Fire Batt 2-S

**Penetration Seal:** 1000 mm (min.) LI (Local Interrupted) or CI (Continuous Interrupted) insulated metallic pipes (single) fitted at any position within the aperture, with 60 mm Bostik FP 320 Fire Batt to both sides of the wall.

Construction details:

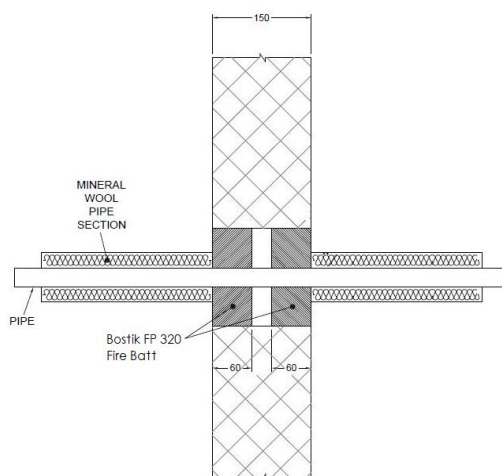

#### A.1.3.1 Double side penetration seal with pipes

Services	Maximum aperture	Insulation	Classification
Mild or stainless steel pipe			
40 mm diameter/1.5-14.2 mm wall*	1200 x 1200 mm	20 mm Stone wool insulation 80 kg/m <sup>3</sup>	EI 240 C/U
40 mm diameter/1.5-14.2 mm wall*	As section 2. 5)	30 mm Stone wool insulation 80 kg/m <sup>3</sup>	E 240 C/U, EI 180 C/U
40 mm diameter/1.5-14.2 mm wall*			
50 mm diameter/1.7-14.2 mm wall*			
60 mm diameter/1.9-14.2 mm wall*			
75 mm diameter/2.2-14.2 mm wall*			
90 mm diameter/2.5-14.2 mm wall*			
100 mm diameter/2.7-14.2 mm wall*			
115 mm diameter/3-14.2 mm wall*			
140 mm diameter/3.5-14.2 mm wall*			
165 mm diameter/ 3.9-14.2 mm wall*			
180 mm diameter/ 4.2-14.2 mm wall*			
200 mm diameter/ 4.6-14.2 mm wall*			
219 mm diameter/ 5.0-14.2 mm wall*			
			E 240 C/U, EI 90 C/U

\* Typical pipe diameters shown, see below graph for intermediate sizes

Services	Maximum aperture	Insulation	Classification
Alupex composite			
16 mm diameter/2.25 mm wall	1200 x 1200 mm	20 mm Stone wool insulation 80 kg/m <sup>3</sup>	EI 240 U/C
16 mm diameter/2.25 mm wall	As section 2. 5)		E 240 U/C EI 180 U/C

Pipe diameter vs Wall thickness

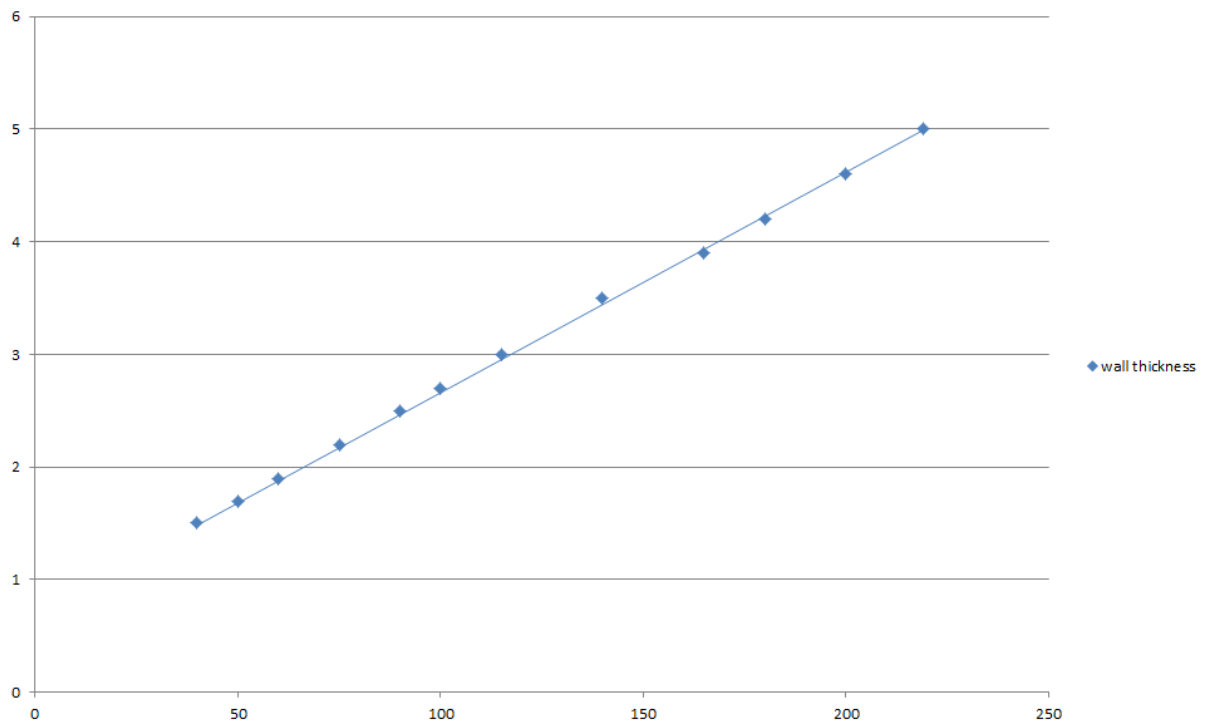

### A.1.4 Pipe penetration seal with 2x Bostik FP 320 Fire Batt 2-S

**Penetration Seal:** CS (Continuous Sustained) insulated metallic pipes fitted at any position within the aperture, with 60 mm Bostik FP 320 Fire Batt 2-S to both sides of the wall. Minimum separation between penetration seals and seal edges of 30 mm.

Construction details:

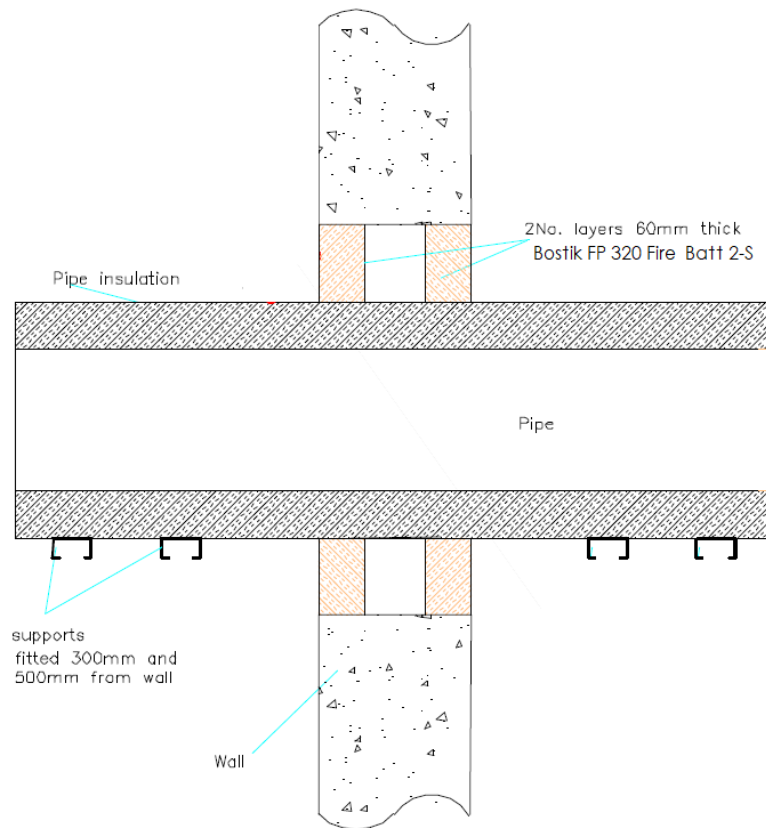

**Configuration 1**

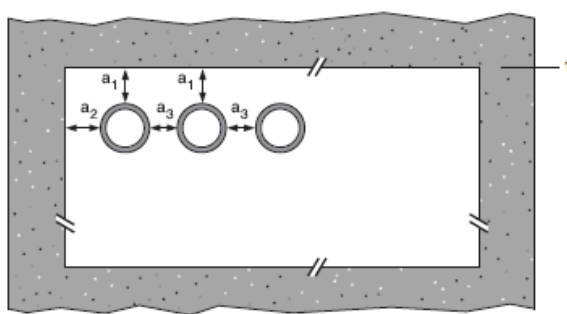

**Configuration 2**

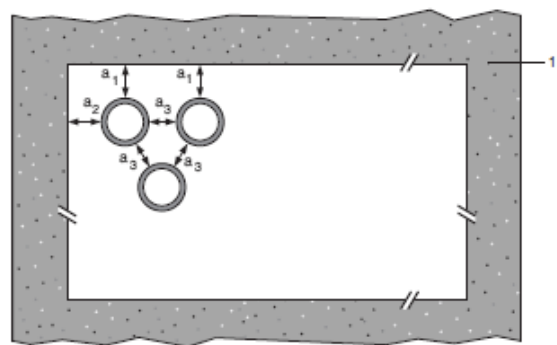

**Key**

- 1 Supporting construction
- a1 Pipe / top edge of seal separation
- a2 Pipe / side edge of seal separation
- a3 Pipe / pipe separation

### A.1.4.1 Double side penetration seal with pipes

Mild or stainless steel pipe	Insulation	Classification
40 mm diameter/1-14.2 mm wall	20 mm thick stone, mineral wool 80 kg/m <sup>3</sup>	<b>E 240 C/U, EI 180 C/U</b>
40 mm diameter/1-14.2 mm wall*	30-80 mm thick stone, mineral wool min. 80 kg/m <sup>3</sup>	
50 mm diameter/1.2-14.2 mm wall*		
60 mm diameter/1.4-14.2 mm wall*		
75 mm diameter/1.6-14.2 mm wall*		
90 mm diameter/1.9-14.2 mm wall*		
100 mm diameter/2.1-14.2 mm wall*		
115 mm diameter/2.4-14.2 mm wall*		
140 mm diameter/2.9-14.2 mm wall*		
165 mm diameter/ 3.4-14.2 mm wall*		
180 mm diameter/ 3.6-14.2 mm wall*		
200 mm diameter/ 4.0-14.2 mm wall*		
219 mm diameter/ 4.3-14.2 mm wall*		
250 mm diameter/ 5.0-14.2 mm wall*		
300 mm diameter/ 5.9-14.2 mm wall*		
324 mm diameter/ 6.35-14.2 mm wall*		

Pipe Diameter vs wall thickness

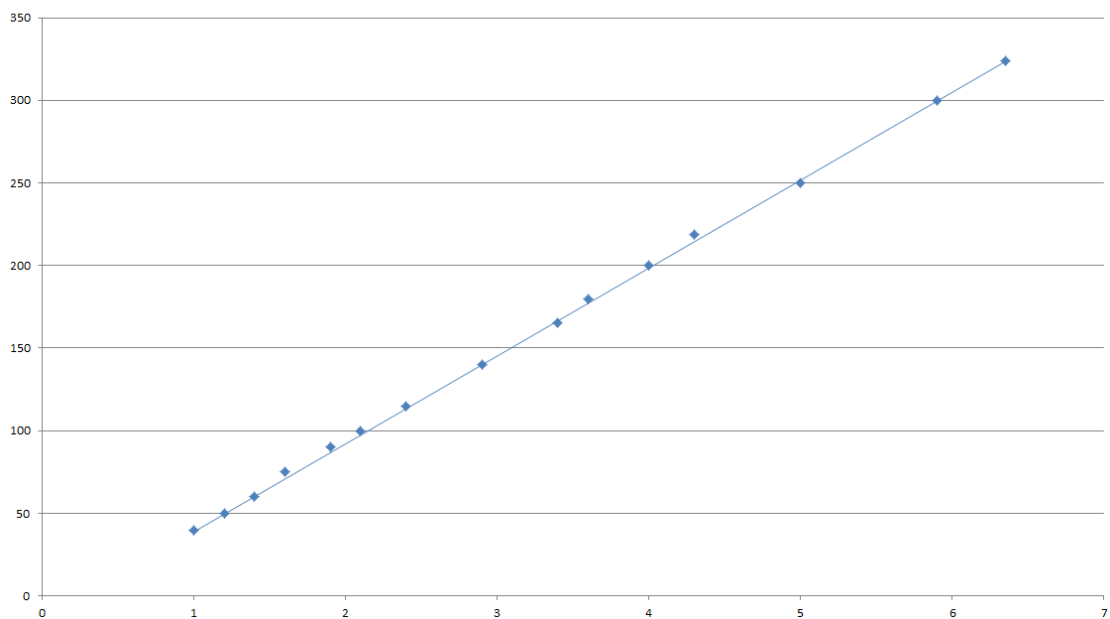

### A.1.5 Pipe penetration seal with 1x 60 mm thick Bostik FP 320 Fire Batt 2-S

**Penetration Seal:** 1000 mm (min.)\* LI (Local Interrupted), CI (Continuous Interrupted) or CS (continuous sustained) insulated metallic and composite pipes (single) fitted at any position within the aperture, with 60 mm Bostik FP 320 Fire Batt to one side of the wall.

Construction details:

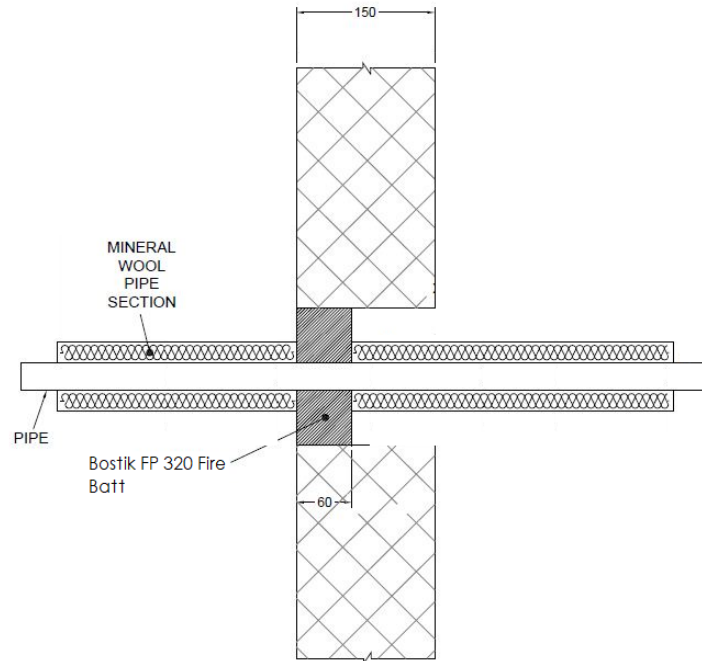

\* 600 mm long insulation required for Alupex pipes

#### A.1.5.1 Single side penetration seal with pipes

Services	Maximum Aperture	Insulation	Classification
Up to 12 mm diameter Copper pipe 0.9-14.2 mm wall	70 x 70 mm	20 mm Stone wool insulation 80 kg/m <sup>3</sup>	EI 240 C/U
Up to 54 mm diameter Copper pipe 0.9-14.2 mm wall	115 x 115 mm		E 240 C/U, EI 120 C/U
75 mm diameter Alupex composite pipe 7.5 mm diameter	200 x 200 mm	30 mm Stone wool insulation 80 kg/m <sup>3</sup>	EI 120 C/C
Up to 54 mm diameter Copper pipe 0.9-14.2 mm wall	As section 2. 5)	20 mm Stone wool insulation 80 kg/m <sup>3</sup>	E 240 C/U, EI 90 C/U
Up to 75 mm diameter Alupex composite pipe 7.5 mm diameter			E 120 C/C, EI 90 C/C
325 mm diameter Steel pipe 6.35-14.2 mm wall		E 120 C/U, EI 90 C/U	

Services	Maximum Aperture	Insulation	Classification
Mild or stainless steel pipe			
40 mm diameter/1.5-14.2 mm wall*	280 x 280 mm	20 mm Stone wool insulation 80 kg/m <sup>3</sup>	EI 240 C/U
40 mm diameter/1.5-14.2 mm wall*		30 mm Stone wool insulation 80 kg/m <sup>3</sup>	
50 mm diameter/1.7-14.2 mm wall*			
60 mm diameter/1.9-14.2 mm wall*			
75 mm diameter/2.2-14.2 mm wall*			
90 mm diameter/2.5-14.2 mm wall*			
100 mm diameter/2.7-14.2 mm wall*			
115 mm diameter/3-14.2 mm wall*			
140 mm diameter/3.5-14.2 mm wall*			
165 mm diameter/ 3.9-14.2 mm wall*			
180 mm diameter/ 4.2-14.2 mm wall*			
200 mm diameter/ 4.6-14.2 mm wall*			
219 mm diameter/ 5.0-14.2 mm wall*			
40 mm diameter/1.5-14.2 mm wall*	As section 2. 5)	20 mm Stone wool insulation 80 kg/m <sup>3</sup>	E 240 C/U, EI 90 C/U
50 mm diameter/1.7-14.2 mm wall*		30 mm Stone wool insulation 80 kg/m <sup>3</sup>	
60 mm diameter/1.9-14.2 mm wall*			
75 mm diameter/2.2-14.2 mm wall*			
90 mm diameter/2.5-14.2 mm wall*			
100 mm diameter/2.7-14.2 mm wall*			
115 mm diameter/3-14.2 mm wall*			
140 mm diameter/3.5-14.2 mm wall*			
165 mm diameter/ 3.9-14.2 mm wall*			
180 mm diameter/ 4.2-14.2 mm wall*			
200 mm diameter/ 4.6-14.2 mm wall*			
219 mm diameter/ 5.0-14.2 mm wall*			

\* Typical pipe diameters shown, see below graph for intermediate sizes

Pipe diameter vs Wall thickness

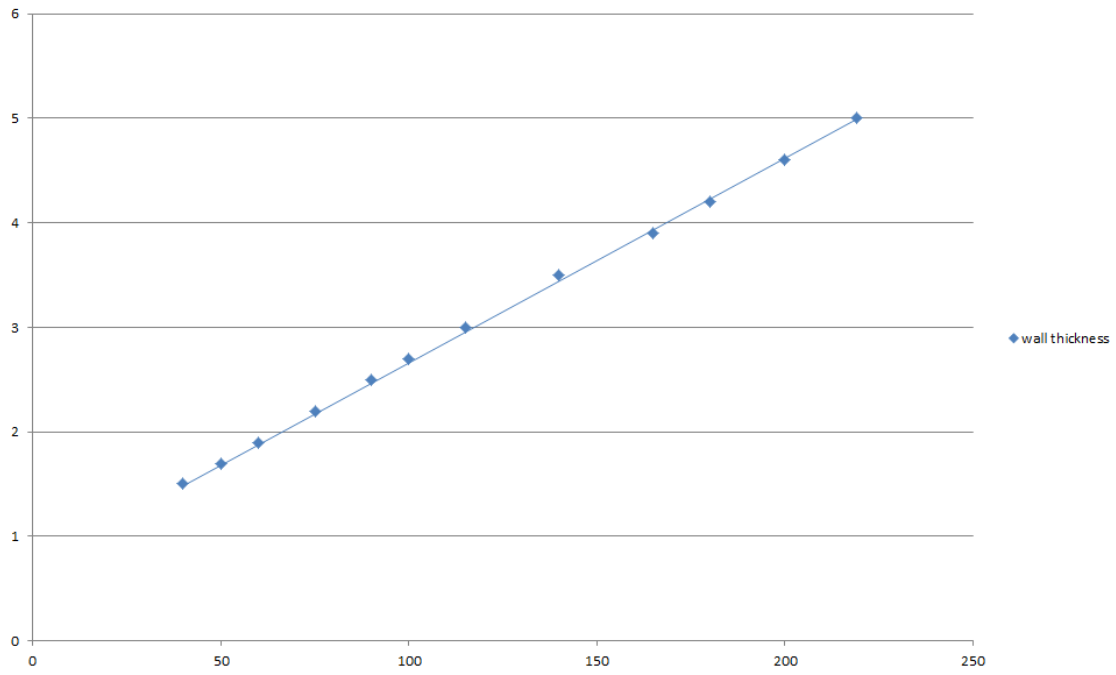



### A.1.5 Pipe penetration seal with 1x Bostik FP 320 Fire Batt 2-S

**Penetration Seal:** CS (Continuous Sustained) insulated metallic pipes fitted at any position within the aperture, with 60 mm Bostik FP 320 Fire Batt 2-S to either side of the wall (or anywhere in between). Bostik FP 340 Pipe Wraps are required to be fitted around combustible pipe insulation.

Construction details:

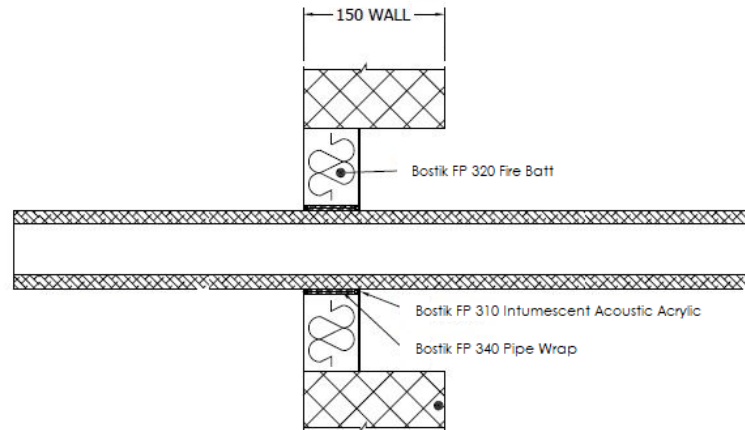

#### A.1.5.1 Single side penetration seal with pipes

Services	Wrap	Insulation	Classification
Mild or stainless steel pipe			
165 mm diameter/ 4.5-14.2 mm wall	50 x 1.8 mm Bostik FP 340 Pipe Wrap fitted centrally	9-25 mm Kaiflex ST/KK insulation	E 120 U/C, E 120 C/U, E 120 C/C, EI 45 U/C, EI 45 C/U, EI 45 C/C
219 mm diameter/ 5-14.2 mm wall	Not required	30 mm stone wool 80 kg/m <sup>3</sup>	E 240 U/C, E 240 C/U, E 240 C/C, EI 60 U/C, EI 60 C/U, EI 60 C/C

**A.1.6 Bostik FP 320 Fire Batt 60 mm 2-S penetration seal (protruding) blank and with cables, in rigid wall min. 150 mm thick**

**Penetration Seal:** Cables fitted at any position within the aperture, with 60 mm Bostik FP 320 Fire Batt 2-S to both sides of the wall. Boards to be separated by minimum 90 mm.

Construction details:

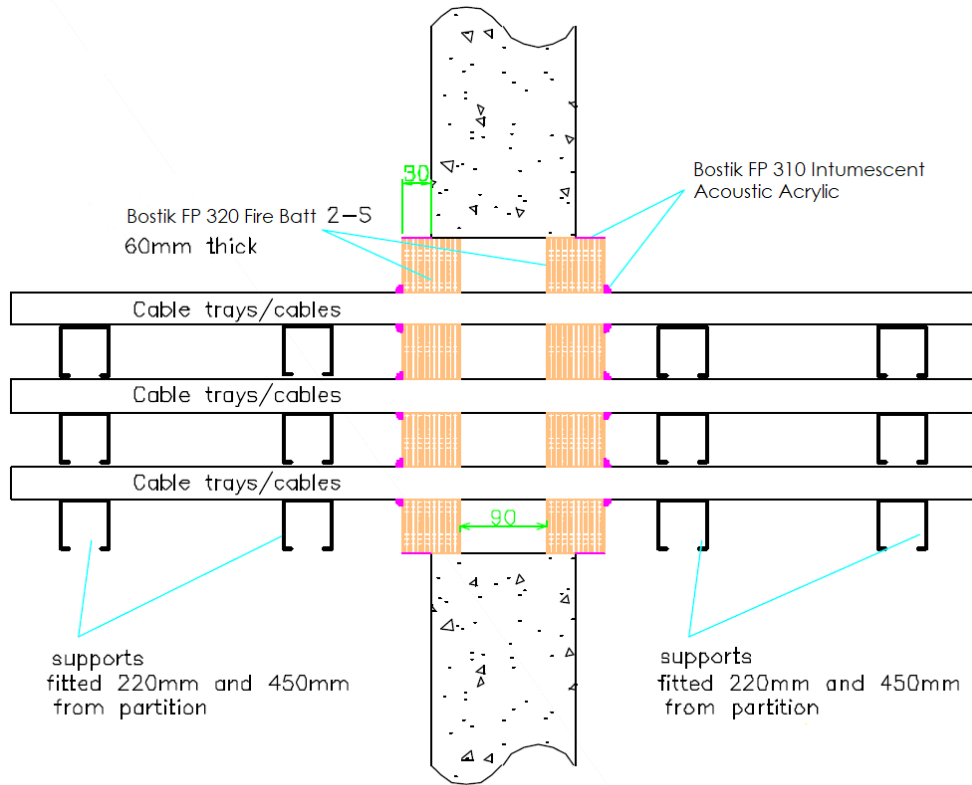

**A.1.6.1 Two side penetration seal with cables**

Services	Maximum aperture	Classification
None (blank)	600 mm wide x 600 mm high	E 240, EI 180
Single or bundled electrical cables up to 21 mm $\varnothing$ , with or without trays		E 240, EI 120
Electrical cables up to 80 mm $\varnothing$ (single, bundled and on trays)		E 240, EI 60
Cables up to 21mm $\varnothing$ in tied bundles up to 100mm $\varnothing$		EI 240
Steel cable trays & ladders		E 240, EI 180
Non-Sheathed wires up to 17 mm $\varnothing$		E 240, EI 180
Non-Sheathed wires up to 24 mm $\varnothing$		E 240, EI 90

**A.1.7 Bostik FP 320 Fire Batt 60 mm 2-S penetration seal (pattress) blank and with cables, in rigid wall min. 150 mm thick**

**Penetration Seal:** Cables fitted at any position within the aperture, with 60 mm Bostik FP 320 Fire Batt 2-S to both sides of the wall. Boards to be pattress fixed with 100 mm steel screws and penny washers at 350 mm centres and with a minimum 50 mm overlap around the opening.

Construction details:

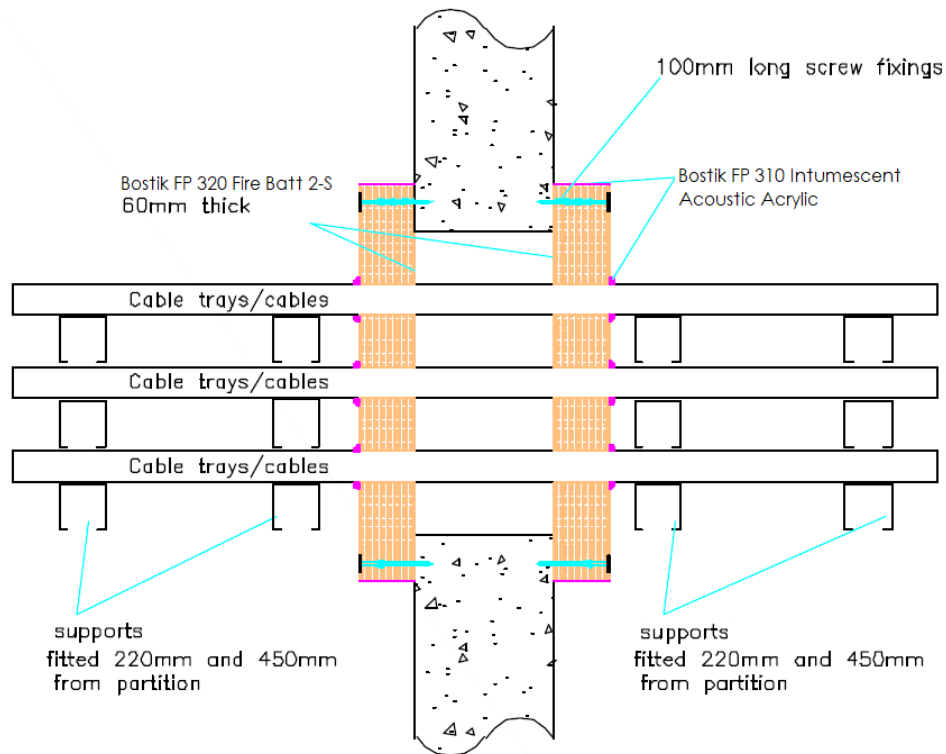

**A.1.7.1 Two side penetration seal with cables**

Services	Maximum aperture	Classification
None (blank)	600 mm wide x 600 mm high	E 240, EI 180
Single or bundled electrical cables up to 50 mm Ø, with or without trays		E 240, EI 90
Single or bundled electrical cables up to 80 mm Ø (single, bundled and on trays)		E 240, EI 60
Cables up to 21mm Ø in tied bundles up to 100mm Ø		EI 240
Steel cable trays & ladders		E 240, EI 180
Non-Sheathed wires up to 24 mm Ø		E 240, EI 120

### A.1.8 Penetration seal with 2x Bostik FP 320 Fire Batt 2-S

**Penetration Seal:** Plastic pipes fitted at any position within the aperture, with 60 mm Bostik FP 320 Fire Batt 2-S to both sides of the wall. Bostik FP 340 Pipe Wraps are required to be fitted around pipes. Min. 30 mm separation between pipes.

Construction details:

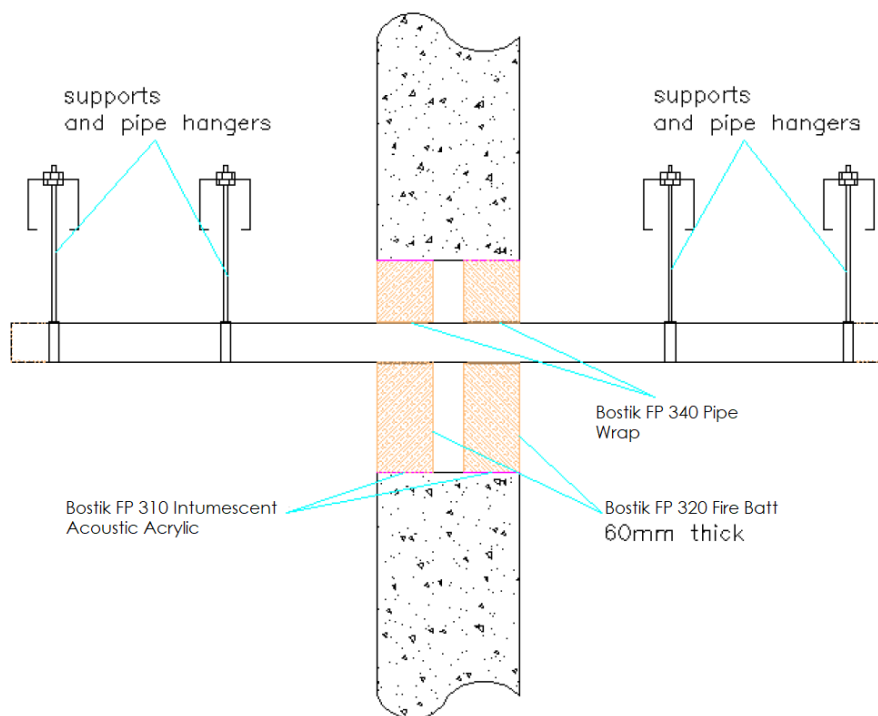

#### A.1.8.1 Double side penetration seal with pipes

Services	Wrap	Classification
<b>PVC-U pipe according to EN 1329-1, EN 1452-1 and EN 1453-1 and PVC-C according to EN 1566-1</b>		
Up to 40 mm diameter / 1.9-3.0 mm wall	50 x 1.8 mm	<b>EI 240 U/C</b>
Up to 110 mm diameter / 2.7-6.6 mm wall	50 x 3.6 mm	
Up to 125 mm diameter / 4.7-7.4 mm wall	50 x 7.2 mm	
Up to 160 mm diameter / 4.0-9.5 mm wall	50 x 10.8 mm	
<b>PE pipe according to EN 1519-1, EN 12201-2 and EN 12666-1, ABS according to EN 1455-1 and pipes made from SAN+PVC according to EN 1565-1</b>		
Up to 40 mm diameter / 2.4-4.6 mm wall	50 x 1.8 mm	<b>EI 240 U/C</b>
Up to 110 mm diameter / 3.4-10.0 mm wall	50 x 3.6 mm	
Up to 125 mm diameter / 3.9-7.4 mm wall	50 x 7.2 mm	
Up to 160 mm diameter / 4.9-9.5 mm wall	50 x 10.8 mm	
<b>PP pipe according to EN 1451-1</b>		
Up to 40 mm diameter / 1.8-5.5 mm wall	50 x 1.8 mm	<b>EI 240 U/C</b>
Up to 110 mm diameter / 2.7-10.0 mm wall	50 x 3.6 mm	<b>EI 240 C/C</b>
Up to 125 mm diameter / 3.1-11.4 mm wall	50 x 7.2 mm	
Up to 160 mm diameter / 4.9-14.6 mm wall	50 x 10.8 mm	

## A.2 Rigid floor constructions according to 2. 2) with floor thickness of minimum 150 mm

### A.2.1 Cable penetration seal with 2x Bostik FP 320 Fire Batt 2-S

**Penetration Seal:** Cables fitted at any position within the aperture, with 60 mm Bostik FP 320 Fire Batt 2-S to both sides of the floor.

Construction details:

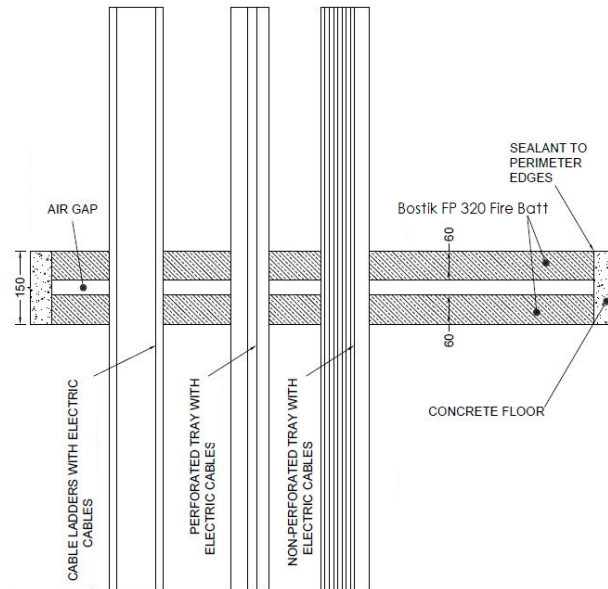

#### A.2.1.1 Double side penetration seal with cables

Services	Maximum aperture	Classification
None (blank)	1200 x 600 mm	EI 180
None (blank)	2400 mm x 1200 mm	E 180, EI 120
Electrical cables up to 21 mm $\varnothing$ (single, bundled and on trays)		EI 120
Electrical cables up to 80 mm $\varnothing$ (single, bundled and on trays)		E 120, EI 60
Cables up to 21mm $\varnothing$ in tied bundles up to 100mm $\varnothing$		EI 120
Steel cable trays & ladders		E 120, EI 60
Non-sheathed wires up to 24 mm $\varnothing$		E 180, EI 45
PVC conduit up to 16 mm $\varnothing$		E 120 C/U, E 120 C/C, EI 90 C/U, EI 90 C/C

## A.2.2 Cable penetration seal with 1x Bostik FP 320 Fire Batt 2-S

**Penetration Seal:** Cables fitted at any position within the aperture, with Bostik FP 320 Fire Batt 2-S positioned to either face of the floor (or anywhere in between).

Construction details:

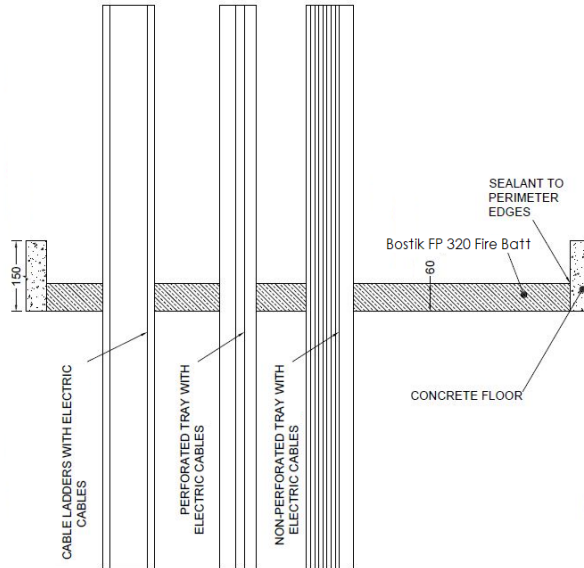

### A.2.2.1 Single side penetration seal with cables

Services	Maximum aperture	Classification
None (blank)	1200 x 600 mm	E 240, EI 120
None (blank)	2400 mm x 1200 mm	E 120, EI 90
Single* electrical cables up to 21 mm $\varnothing$		E 120, EI 30
Single* electrical cables up to 21 mm $\varnothing$	600 mm x 1200 mm	E 240, EI 30
Electrical cables up to 21 mm $\varnothing$ (single, bundled and on trays)	2400 mm x 1200 mm	E 90, EI 45
Electrical cables up to 80 mm $\varnothing$ (single, bundled and on trays)		E 90, EI 30
Cables up to 21mm $\varnothing$ in tied bundles up to 100mm $\varnothing$		EI 45
Steel cable trays & ladders		EI 45
Non-sheathed wires up to 17 mm $\varnothing$		E 45, EI 30
Non-sheathed wires up to 24 mm $\varnothing$		E 45, EI 20
PVC conduit up to 16 mm $\varnothing$		EI 45 C/U, EI 45 C/C
Steel or copper conduit up to 16 mm $\varnothing$		E 45 C/U, EI 15 C/U

### A.2.3 Pipe penetration seal with 2x Bostik FP 320 Fire Batt 2-S

**Penetration Seal:** 1000 mm (min.) LI (Local Interrupted) or CI (Continuous Interrupted) insulated metallic pipes (single) fitted at any position within the aperture, with 2 layers of 60 mm Bostik FP 320 Fire Batt 2-S together within the floor.

Construction details:

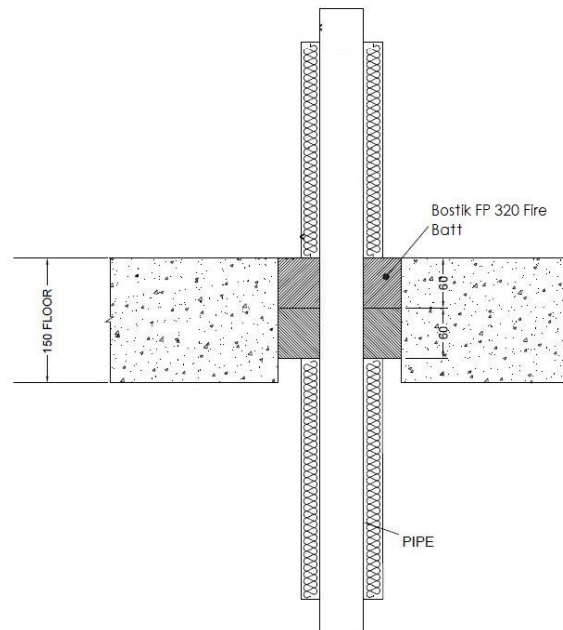

### A.2.3.1 Two layer penetration seal with pipes

Services	Maximum aperture	Insulation	Classification
Mild or stainless steel pipe			
40 mm diameter/1.5-14.2 mm wall*	1200 x 600 mm	20 mm Stone wool insulation 80 kg/m <sup>3</sup>	EI 180 C/U
40 mm diameter/1.5-14.2 mm wall*	280 x 280 mm		EI 240 C/U
40 mm diameter/1.5-14.2 mm wall*	2400 x 1200 mm		30 mm Stone wool insulation 80 kg/m <sup>3</sup>
40 mm diameter/1.5-14.2 mm wall*		E 180 C/U, EI 60 C/U	
50 mm diameter/1.7-14.2 mm wall*			
60 mm diameter/1.8-14.2 mm wall*			
75 mm diameter/2.1-14.2 mm wall*			
90 mm diameter/2.3-14.2 mm wall*			
100 mm diameter/2.5-14.2 mm wall*			
115 mm diameter/2.8-14.2 mm wall*			
140 mm diameter/3.2-14.2 mm wall*			
165 mm diameter/ 3.6-14.2 mm wall*			
180 mm diameter/ 3.9-14.2 mm wall*			
200 mm diameter/ 4.2-14.2 mm wall*			
219 mm diameter/ 4.5-14.2 mm wall*			

\* Typical pipe diameters shown, see below graph for intermediate sizes

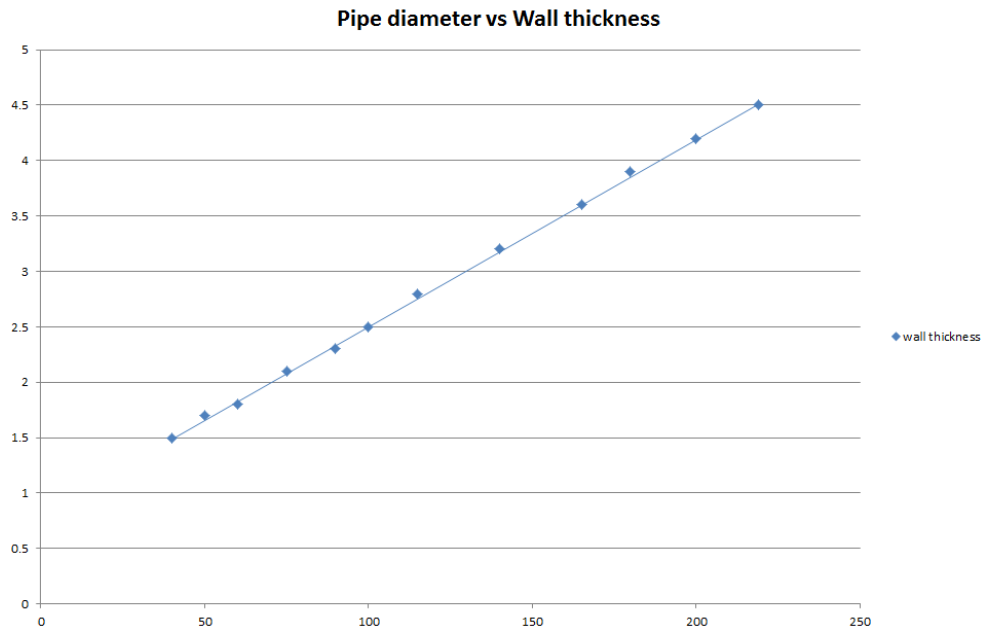



#### A.2.4 Pipe penetration seal with 1x Bostik FP 320 Fire Batt 2-S

**Penetration Seal:** 1000 mm (min.)\* LI (Local Interrupted) or CI (Continuous Interrupted) insulated metallic pipes (single) fitted at any position within the aperture, with 60 mm Bostik FP 320 Fire Batt 2-S to either side of the floor (or anywhere in between).

Construction details:

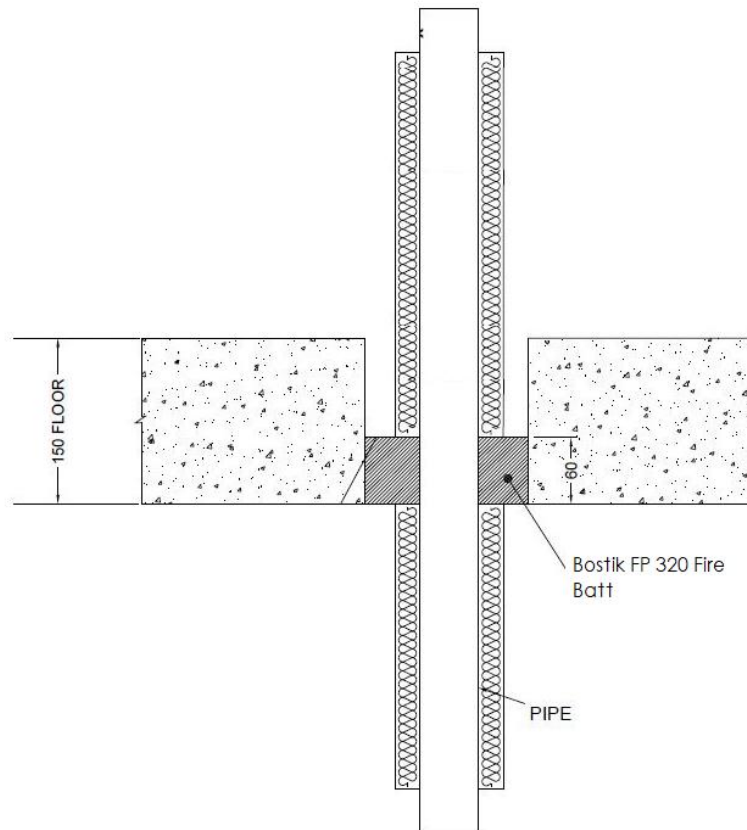

##### A.2.4.1 Single side penetration seal with pipes

Services	Maximum Aperture	Insulation	Classification
Up to 12 mm diameter Copper pipe 0.9-14.2 mm wall	1200 x 600 mm	20 mm Stone wool insulation 80 kg/m <sup>3</sup>	<b>E 240 C/U, EI 45 C/U</b>
Up to 54 mm diameter Copper pipe 0.9-14.2 mm wall	1200 x 600 mm		<b>E 240 C/U</b>
	2400 mm x 1200 mm		<b>E 120 C/U</b>
114 mm diameter mild or stainless steel pipe 11-14.2 mm wall	600 x 1200 mm	None	<b>E 240 C/C, EI 20 C/C</b>
	2400 mm x 1200 mm		<b>E 120 C/C, EI 20 C/C</b>

Services	Maximum Aperture	Insulation	Classification
Mild or stainless steel pipe			
40 mm diameter/1.5-14.2 mm wall*	600 x 1200 mm	20 mm Stone wool insulation 80 kg/m <sup>3</sup>	E 240 C/U, EI 60 C/U
40 mm diameter/1.5-14.2 mm wall*		30 mm Stone wool insulation 80 kg/m <sup>3</sup>	E 240 C/U, EI 90 C/U
50 mm diameter/1.7-14.2 mm wall*			
60 mm diameter/1.8-14.2 mm wall*			
75 mm diameter/2.1-14.2 mm wall*			
90 mm diameter/2.3-14.2 mm wall*			
100 mm diameter/2.5-14.2 mm wall*			
115 mm diameter/2.8-14.2 mm wall*			
140 mm diameter/3.2-14.2 mm wall*			
165 mm diameter/ 3.6-14.2 mm wall*			
180 mm diameter/ 3.9-14.2 mm wall*			
200 mm diameter/ 4.2-14.2 mm wall*			
219 mm diameter/ 4.5-14.2 mm wall*			
40 mm diameter/1.5-14.2 mm wall*	2400 mm wide by 1200 mm high	20 mm Stone wool insulation 80 kg/m <sup>3</sup>	E 120 C/U, EI 60 C/U
40 mm diameter/1.5-14.2 mm wall*		30 mm Stone wool insulation 80 kg/m <sup>3</sup>	E 120 C/U, EI 90 C/U
50 mm diameter/1.7-14.2 mm wall*			
60 mm diameter/1.8-14.2 mm wall*			
75 mm diameter/2.1-14.2 mm wall*			
90 mm diameter/2.3-14.2 mm wall*			
100 mm diameter/2.5-14.2 mm wall*			
115 mm diameter/2.8-14.2 mm wall*			
140 mm diameter/3.2-14.2 mm wall*			
165 mm diameter/ 3.6-14.2 mm wall*			
180 mm diameter/ 3.9-14.2 mm wall*			
200 mm diameter/ 4.2-14.2 mm wall*			
219 mm diameter/ 4.5-14.2 mm wall*			

\* Typical pipe diameters shown, see below graph for intermediate sizes

Pipe diameter vs Wall thickness

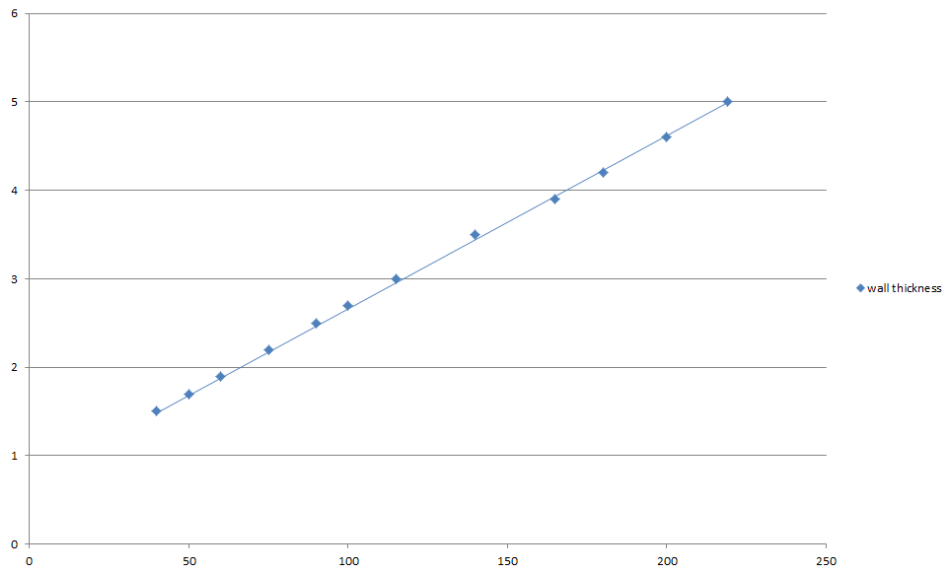

Services	Maximum Aperture	Insulation (minimum)	Classification
Geberit Mepla MLC (PE-Xb/Aluminium/PE-HD pipe)			
16 mm diameter/2.25 mm wall	75 x 75 mm		E 240 C/C, EI 180 C/C
16 mm diameter/2.25 mm wall	600 x 1200 mm	500 mm long, 20 mm Stone wool insulation 80 kg/m <sup>3</sup>	E 240 C/C, EI 90 C/C
20 mm diameter/2.5 mm wall			
26 mm diameter/3 mm wall			
32 mm diameter/3 mm wall			
40 mm diameter/3.5 mm wall			
50 mm diameter/4 mm wall			
63 mm diameter/4.5 mm wall			
75 mm diameter/4.7 mm wall			
16 mm diameter/2.25 mm wall	2400 mm x 1200 mm	500 mm long, 20 mm Stone wool insulation 80 kg/m <sup>3</sup>	E 120 C/C, EI 90 C/C
20 mm diameter/2.5 mm wall			
26 mm diameter/3 mm wall			
32 mm diameter/3 mm wall			
40 mm diameter/3.5 mm wall			
50 mm diameter/4 mm wall			
63 mm diameter/4.5 mm wall			
75 mm diameter/4.7 mm wall			

### A.2.5 Pipe penetration seal with 1x Bostik FP 320 Fire Batt 2-S

**Penetration Seal:** Combustible pipes fitted at any position within the aperture, with 50 mm Bostik FP 320 Fire Batt 2-S at mid-depth of the floor. Bostik FP 340 Pipe Wraps are required to be fitted around combustible pipe insulation. Maximum aperture size 2400 mm x 1200 mm

Construction details:

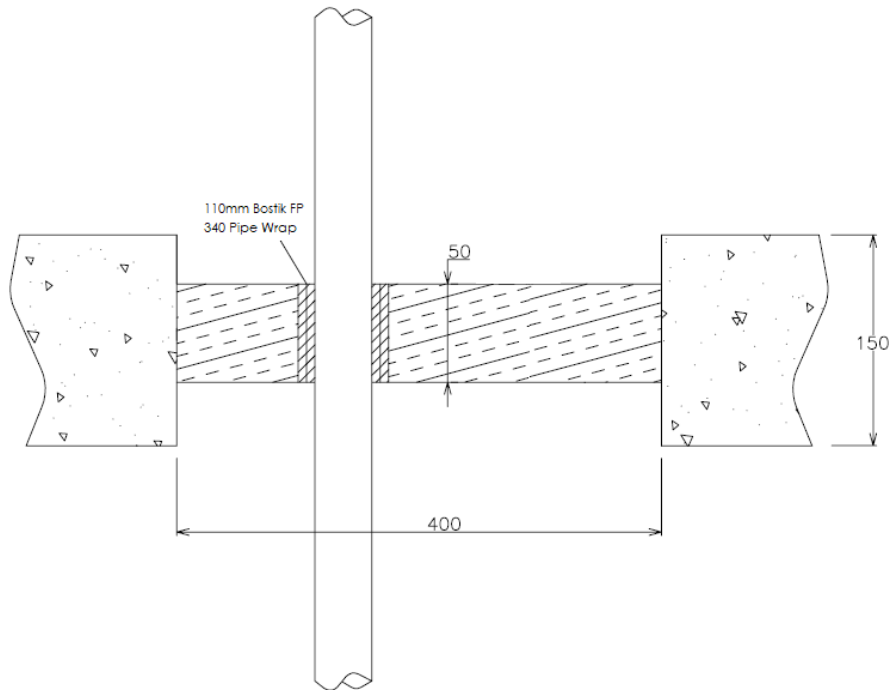

#### A.2.5.1 Central penetration seal with pipes

Services	Wrap	Classification
PVC-U pipe according to EN 1329-1, EN 1452-1 and EN 1453-1* 110 mm diameter/ 3.4mm wall	50 x 3.6 mm Bostik FP 340 Pipe Wrap	EI 90 U/C, EI 90 C/C

### A.2.6 Pipe penetration seal with 1x Bostik FP 320 Fire Batt 2-S

**Penetration Seal:** CS (Continuous Sustained) insulated metallic pipes fitted at any position within the aperture, with 60 mm Bostik FP 320 Fire Batt 2-S to either side of the floor (or anywhere in between). Bostik FP 340 Pipe Wraps are required to be fitted around combustible pipe insulation. Maximum aperture size 2400 mm x 1200 mm

Construction details:

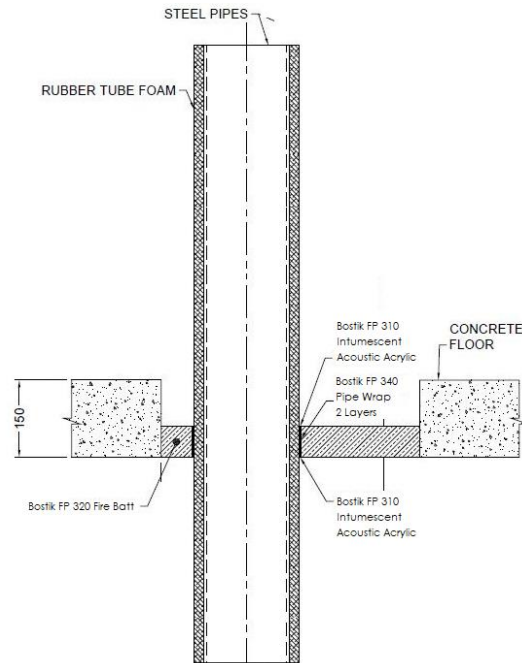

#### A.2.6.1 Single side penetration seal with pipes

Services	Wrap	Insulation	Classification
Mild or stainless steel pipe			
165 mm diameter/ 4.5-14.2 mm wall	50 x 3.6 mm Bostik FP 340 Pipe Wrap fitted at bottom of seal	13 mm Kaiflex ST insulation	E 90 C/U, EI 45 C/U
		19 mm Kaiflex ST insulation	EI 90 C/U
	Not required	25-40 mm stone wool 80 kg/m <sup>3</sup>	E 90 C/U, EI 60 C/U

### A.2.7 Pipe penetration seal with 2x Bostik FP 320 Fire Batt 2-S

**Penetration Seal:** CS (Continuous Sustained) insulated metallic pipes fitted at any position within the aperture, with 60 mm Bostik FP 320 Fire Batt 2-S to both sides of the floor. Bostik FP 340 Pipe Wraps are required to be fitted around combustible pipe insulation at the soffit. Maximum aperture size 2400 mm x 1200 mm

Construction details:

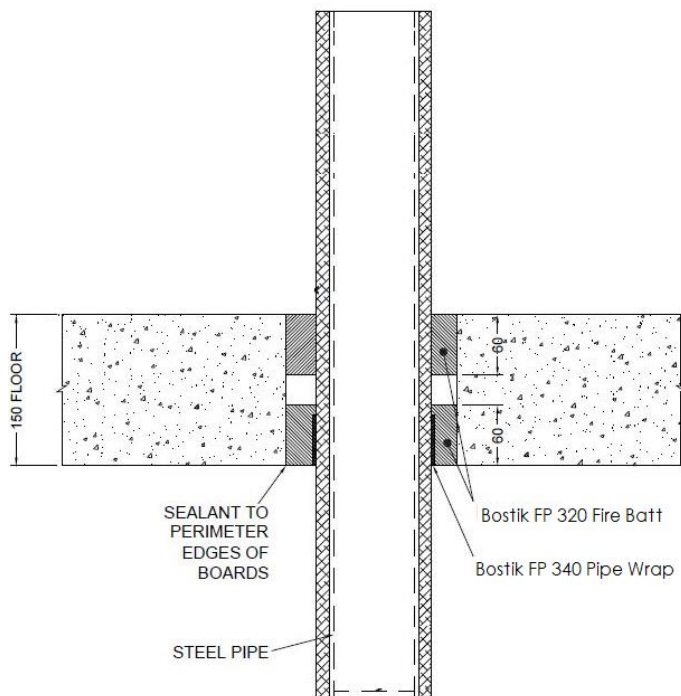

#### A.2.7.1 Double side penetration seal with pipes

Services	Wrap	Insulation	Classification
Mild or stainless steel pipe	50 x 1.8 mm Bostik FP 340 Pipe Wrap	13 mm Kaiflex ST insulation	<b>E 180 C/U, EI 120 C/U</b>
40 mm diameter/ 1-14.2 mm wall			

### A.2.8 Pipe penetration seal with 2x Bostik FP 320 Fire Batt 2-S (back to back)

**Penetration Seal:** CS (Continuous Sustained) insulated metallic and composite pipes fitted at any position within the aperture, with two layers of 60 mm Bostik FP 320 Fire Batt 1-S installed together to either side of the floor (or anywhere in between). Bostik FP 340 Pipe Wraps are required to be fitted around combustible pipe insulation at the bottom of the seal. Maximum aperture size 2400 mm x 1200 mm

Construction details:

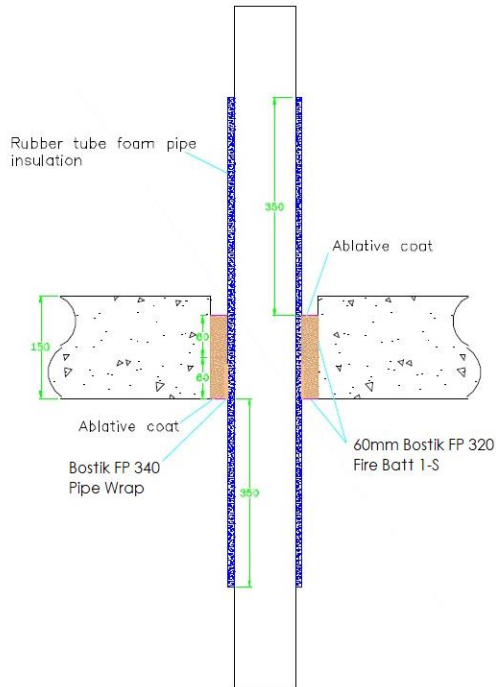

### A.2.8.1 Back to back penetration seal with pipes

Services	Wrap	Insulation	Classification
Copper pipe	50 x 3.6 mm Bostik FP 340 Pipe Wrap fitted to both sides of the seal	9-13 mm Kaiflex ST insulation	<b>E240 C/C, EI 60 C/C</b>
12-54 mm diameter/1-1.2 mm wall		13-25 mm Kaiflex ST insulation	<b>E 180 C/C, EI 45 C/C</b>
Geberit Mepla MLC (PE-Xb/Aluminium/PE-HD pipe)			
16 mm diameter/2.25 mm wall	50 x 3.6 mm Bostik FP 340 Pipe Wrap fitted to both sides of the seal	9 mm Kaiflex ST insulation	<b>EI 120 C/C</b>
20 mm diameter/2.5 mm wall			
26 mm diameter/3 mm wall			
32 mm diameter/3 mm wall			
40 mm diameter/3.5 mm wall			
50 mm diameter/4 mm wall			
63 mm diameter/4.5 mm wall		13-25 mm Kaiflex ST insulation	<b>E 60 C/C, EI 45 C/C</b>
75 mm diameter/4.7 mm wall			
16 mm diameter/2.25 mm wall			
20 mm diameter/2.5 mm wall			
26 mm diameter/3 mm wall			
32 mm diameter/3 mm wall			
40 mm diameter/3.5 mm wall			
50 mm diameter/4 mm wall			
63 mm diameter/4.5 mm wall			
75 mm diameter/4.7 mm wall			



**A.3 Flexible wall constructions according to 2. 2) with wall thickness of minimum 75 mm and 1 x layers of 12.5 mm Type F Gypsum board on both faces**

**A.3.1 Cable penetration seal with 2x Bostik FP 320 Fire Batt 30 1-S**

**Penetration Seal:** Cables fitted at any position within the aperture, with 30 mm Bostik FP 320 Fire Batt 1-S to both sides of the wall. Minimum 30 mm separation between pipes

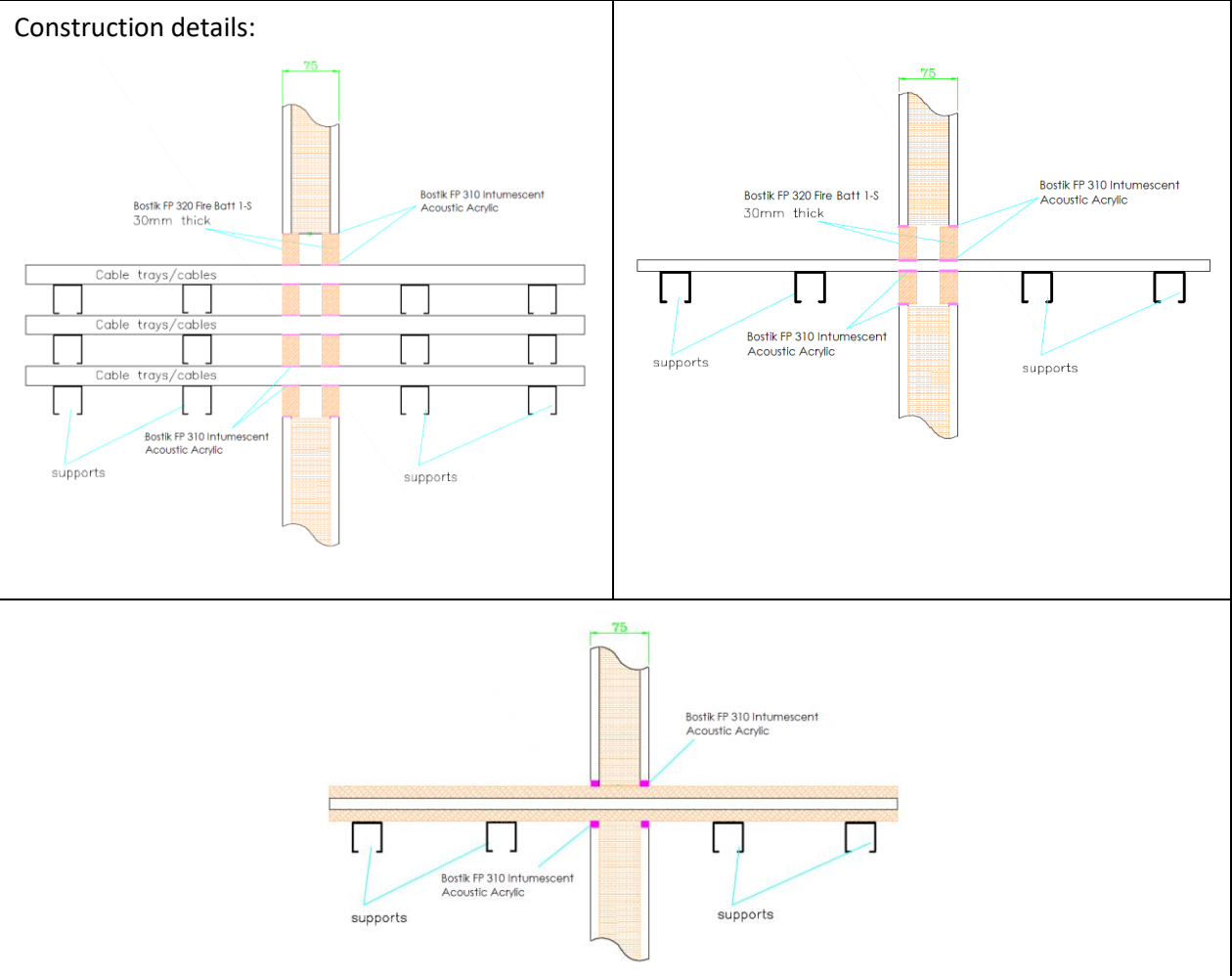

**A.3.1.1 Double side penetration seal with cables**

Services	Maximum aperture	Classification
Electrical cables up to 21 mm Ø (single, bundled and on trays)	1200 mm wide x 600 mm high	EI 45
Electrical cables up to 80 mm Ø (single, bundled and on trays)		E 45, EI 30
Cables including telecoms up to 21mm Ø in tied bundles up to 100mm Ø		
Steel cable trays & ladders		E 45, EI 20
Unsheathed wires up to 24 mm Ø		
uPVC* pipe 6 mm diameter / 1.0 mm wall		EI 45
uPVC* pipe 32 mm diameter / 1.8 mm wall		

\* PVC-U pipe according to EN 1329-1, EN 1452-1 and EN 1453-1 and PVC-C according to EN 1566-1

Services	Maximum Aperture	Insulation CS	Classification
Mild or stainless steel pipe	1200 mm wide x 600 mm high	None	EI 45 C/U
4 mm diameter/0.7-14.2 mm wall			E 45 C/U, EI 30 C/U
22 mm diameter/2.0-14.2 mm wall		20 mm Stone wool insulation 80 kg/m <sup>3</sup>	EI 45 C/U
40 mm diameter/1.0-14.2 mm wall*			EI 45 C/U
40 mm diameter/1.0-14.2 mm wall*		30 mm Stone wool insulation 80 kg/m <sup>3</sup>	
50 mm diameter/1.7-14.2 mm wall*			
60 mm diameter/1.8-14.2 mm wall*			
75 mm diameter/2.1-14.2 mm wall*			
90 mm diameter/2.3-14.2 mm wall*			
100 mm diameter/2.5-14.2 mm wall*			
115 mm diameter/2.8-14.2 mm wall*			
140 mm diameter/3.2-14.2 mm wall*			
165 mm diameter/ 3.6-14.2 mm wall*			
180 mm diameter/ 3.9-14.2 mm wall*			
200 mm diameter/ 4.2-14.2 mm wall*			
219 mm diameter/ 4.5-14.2 mm wall*			
250 mm diameter/ 5.0-14.2 mm wall*			
300 mm diameter/ 5.9-14.2 mm wall*			
324 mm diameter/ 6.35-14.2 mm wall*			

\* Typical pipe diameters shown, see below graph for intermediate sizes

CS – Continuous Sustained

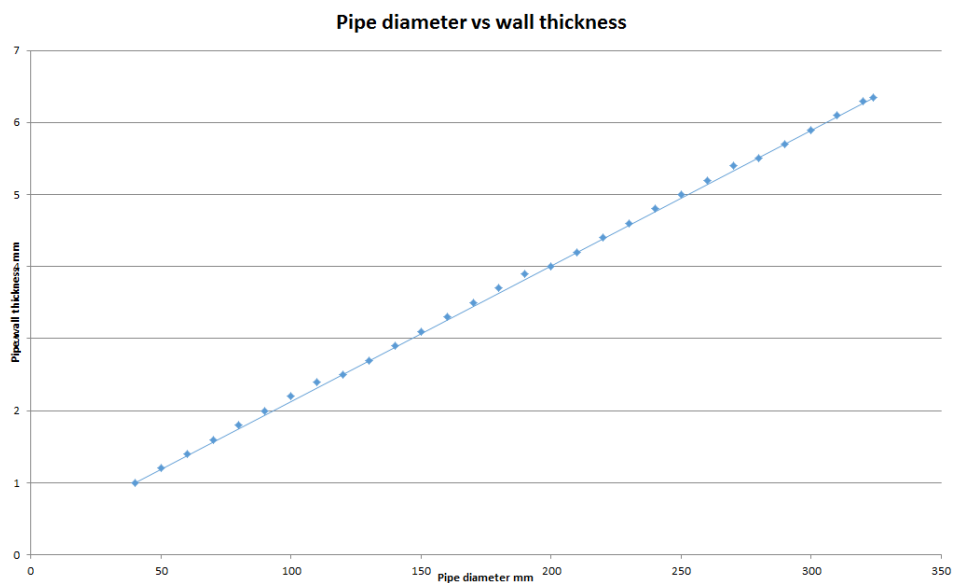

**A.4 Flexible wall constructions according to 2. 2) with wall thickness of minimum 100 mm and 2 x layers of 12.5 mm Type F Gypsum board on both faces**

**A.4.1 Cable penetration seal with 2x Bostik FP 320 Fire Batt 1-S**

**Penetration Seal:** Cables fitted at any position within the aperture, with 50 mm Bostik FP 320 Fire Batt 1-S to both sides of the wall.

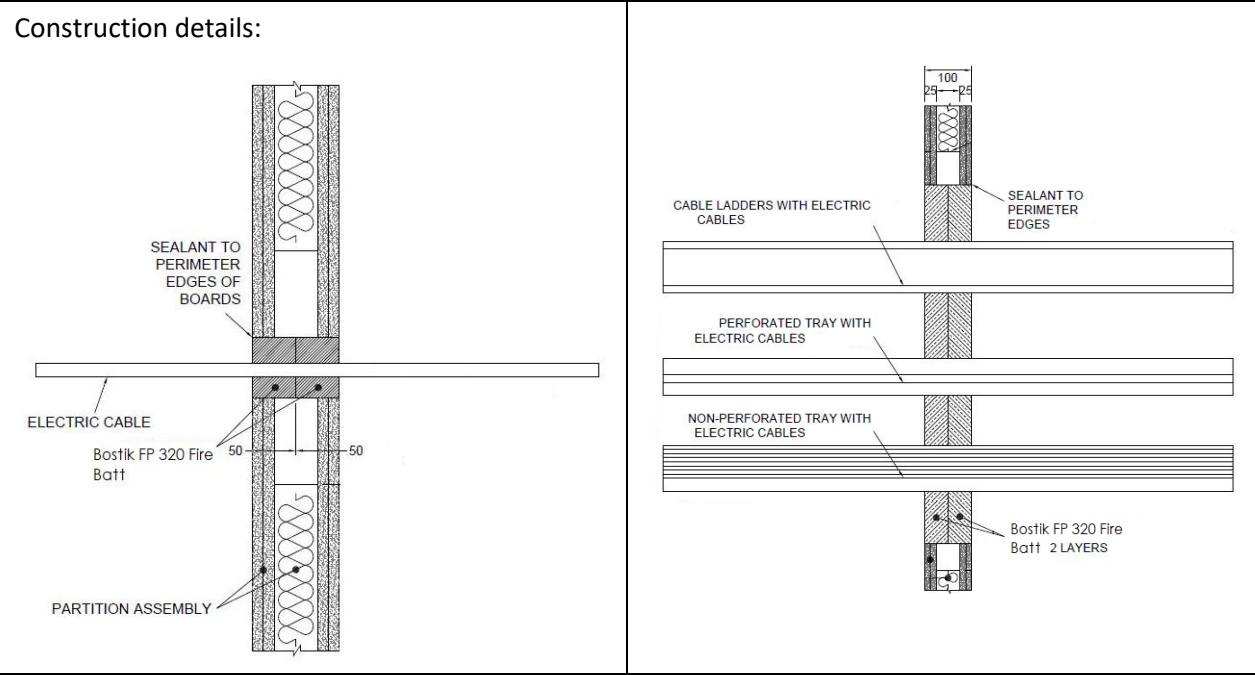

Note: Insulated metal pipes may also be included within the same seal as cables subject to minimum 100 mm separation. See separate classification for pipes.

**A.4.1.1 Double side penetration seal with cables**

Services	Maximum aperture	Classification
None (blank)	2400 mm wide x 1200 mm high	EI 120
Single electrical cables up to 21 mm Ø		E 120, EI 60
Electrical cables up to 80 mm Ø (single, bundled and on trays)		EI 60
Cables up to 21mm Ø in tied bundles up to 100mm Ø		
Steel cable trays & ladders		EI 60 C/U
Steel conduit up to 16 mm Ø		E 60 C/U, EI 45 C/U
copper conduit up to 16 mm Ø		E 60, EI 30
Unsheathed wires up to 24 mm Ø		EI 60 C/U, EI 60 C/C
PVC conduit up to 16 mm Ø		

### A.4.2 Pipe penetration seal with 2x Bostik FP 320 Fire Batt 1-S

**Penetration Seal:** CS (Continuous Sustained) insulated metallic pipes fitted at any position within the aperture, with 50 mm Bostik FP 320 Fire Batt 1-S to both sides of the wall. Minimum separation between penetration seals and seal edges of 30 mm.

Construction details:

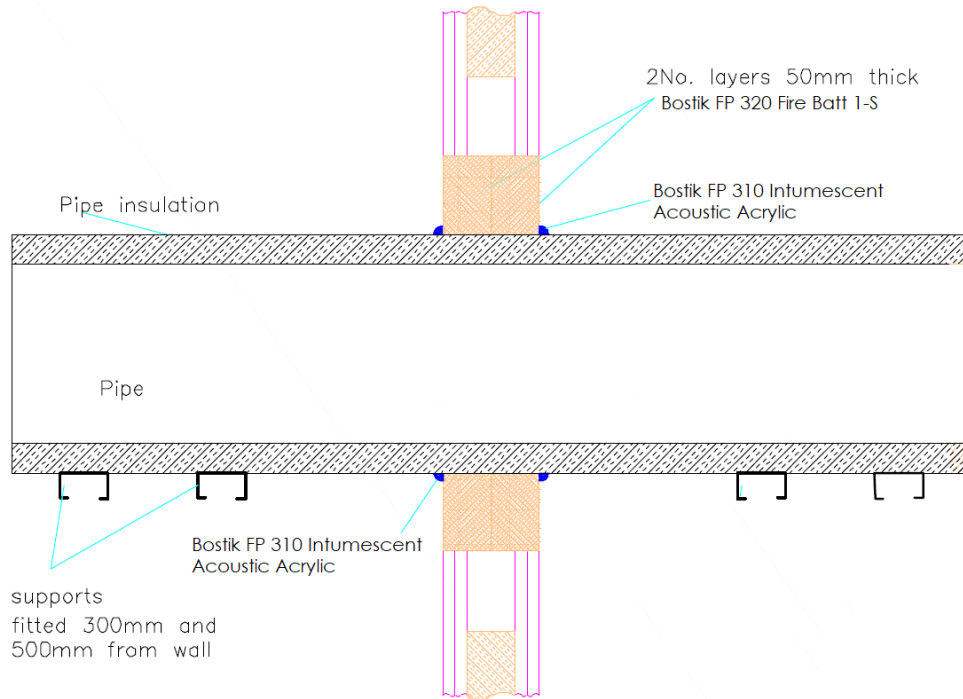

**Configuration 1**

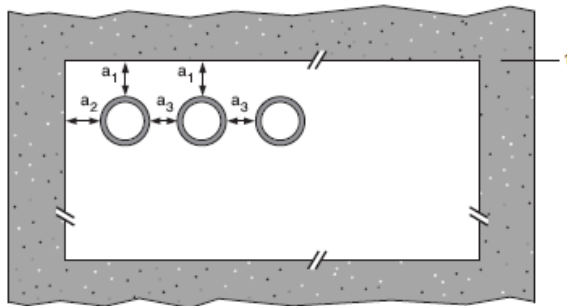

**Configuration 2**

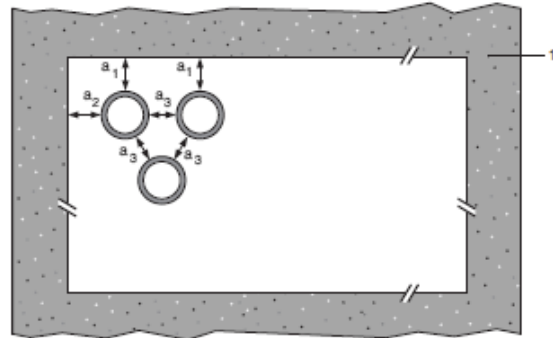

**Key**

- 1 Supporting construction
- a1 Pipe / top edge of seal separation
- a2 Pipe / side edge of seal separation
- a3 Pipe / pipe separation

#### A.4.2.1 Double side penetration seal with pipes

Mild or stainless steel pipe	Insulation	Classification
40 mm diameter/1-14.2 mm wall	20 mm thick stone, mineral wool 80 kg/m <sup>3</sup>	EI 120 C/U
40 mm diameter/1-14.2 mm wall*	30-80 mm thick stone, mineral wool min. 80 kg/m <sup>3</sup>	
50 mm diameter/1.2-14.2 mm wall*		
60 mm diameter/1.4-14.2 mm wall*		
75 mm diameter/1.6-14.2 mm wall*		
90 mm diameter/1.9-14.2 mm wall*		
100 mm diameter/2.1-14.2 mm wall*		
115 mm diameter/2.4-14.2 mm wall*		
140 mm diameter/2.9-14.2 mm wall*		
165 mm diameter/ 3.4-14.2 mm wall*		
180 mm diameter/ 3.6-14.2 mm wall*		
200 mm diameter/ 4.0-14.2 mm wall*		
219 mm diameter/ 4.3-14.2 mm wall*		
250 mm diameter/ 5.0-14.2 mm wall*		
300 mm diameter/ 5.9-14.2 mm wall*		
324 mm diameter/ 6.35-14.2 mm wall*		
PEX pipe in pipe system	Insulation	Classification
15 mm diameter x 2.5 mm wall inner /25mm diameter outer	None	EI 90 C/C

Pipe Diameter vs wall thickness

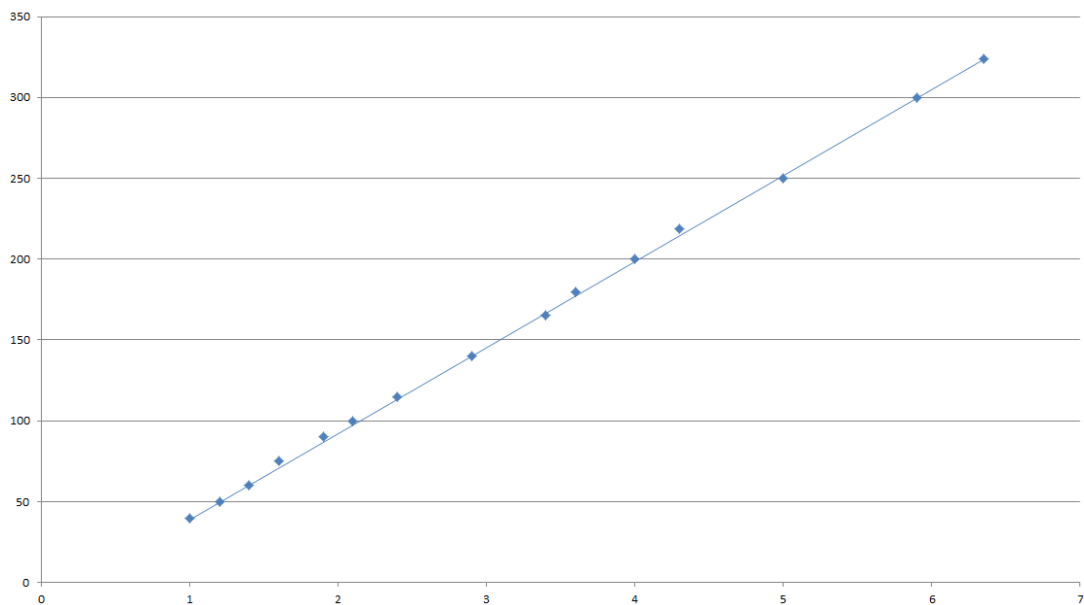

<b>Mild or stainless steel pipe</b>	<b>Insulation</b>	<b>Classification</b>
4 mm diameter/1-14.2 mm wall	None	<b>EI 120 C/U</b>
22 mm diameter/2-14.2 mm wall		<b>E 120 C/U, EI 60 C/U</b>
<b>Copper, mild or stainless steel pipe</b>	<b>Insulation</b>	<b>Classification</b>
6 mm diameter/0.7-14.2 mm wall	None	<b>E 120 C/C, EI 60 C/C</b>
<b>PE-Xb/Al/PE-Xb pipe</b>	<b>Insulation</b>	<b>Classification</b>
16 -20 mm diameter/2.0 mm wall	None	<b>EI 120 C/C</b>
<b>PVC-U* pipe</b>	<b>Insulation</b>	<b>Classification</b>
6 mm diameter/1.0 mm wall	None	<b>EI 120 U/C</b>
6-32 mm diameter/1.8-2.4 mm wall		<b>E 90 U/C, EI 60 U/C</b>
32 mm diameter/2.4 mm wall		<b>EI 90 U/C</b>
<b>PE^ pipe</b>	<b>Insulation</b>	<b>Classification</b>
20 mm diameter/2.0 mm wall	None	<b>E 120 U/C, EI 90 U/C</b>
20-32 mm diameter/2.0-3.0 mm wall		<b>EI 60 U/C</b>
32 mm diameter/3.0 mm wall		<b>EI 90 U/C</b>
<b>PP pipe</b>	<b>Insulation</b>	<b>Classification</b>
20 mm diameter/2.2 mm wall	None	<b>E 120 U/C, EI 60 U/C</b>
32 mm diameter/1.8 mm wall		

\* PVC-U pipe according to EN 1329-1, EN 1452-1 and EN 1453-1 and PVC-C according to EN 1566-1

^ PE pipe according to EN 1519-1, EN 12201-2 and EN 12666-1, ABS according to EN 1455-1 and pipes made from SAN+PVC according to EN 1565-1

### A.4.3 Pipe penetration seal with 2x Bostik FP 320 Fire Batt 1-S

**Penetration Seal:** CS (Continuous Sustained) insulated metallic pipes fitted at any position within the aperture, with 50 mm Bostik FP 320 Fire Batt 1-S to both sides of the wall. Minimum separation between penetration seals and seal edges of 30 mm. Bostik FP 340 Pipe Wraps are required to be fitted around the pipe insulation.

Construction details:

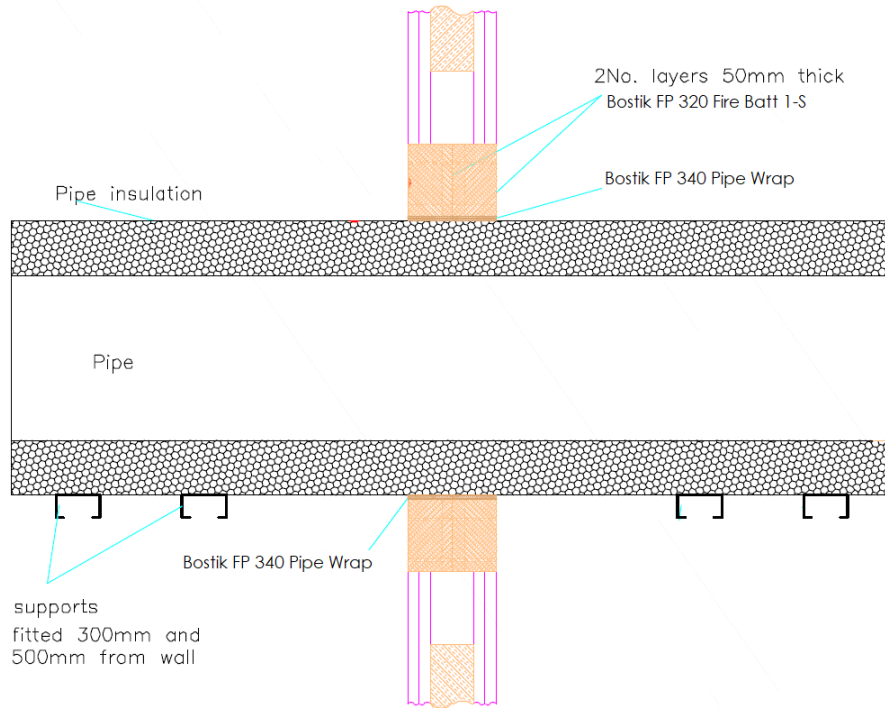

#### Configuration 1

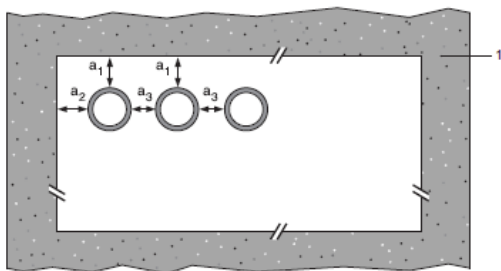

#### Configuration 2

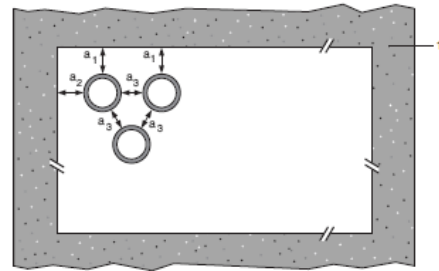

#### Key

- 1 Supporting construction
- a1 Pipe / top edge of seal separation
- a2 Pipe / side edge of seal separation
- a3 Pipe / pipe separation

### A.4.3.1 Double side penetration seal with pipes

Mild or stainless steel pipe	Insulation	Bostik FP 340 Pipe Wrap	Classification
40 mm diameter/1-14.2 mm wall	32 mm thick K-flex Elastomeric insulation	<b>3 layers 50 x 1.8 mm</b>	<b>EI 90 C/U</b>
40 mm diameter/1-14.2 mm wall*	32-50 mm thick K-flex Elastomeric insulation		
50 mm diameter/1.2-14.2 mm wall*			
60 mm diameter/1.4-14.2 mm wall*			
75 mm diameter/1.6-14.2 mm wall*			
90 mm diameter/1.9-14.2 mm wall*			
100 mm diameter/2.1-14.2 mm wall*			
115 mm diameter/2.4-14.2 mm wall*			
140 mm diameter/2.9-14.2 mm wall*			
165 mm diameter/ 3.4-14.2 mm wall*			
180 mm diameter/ 3.6-14.2 mm wall*			
200 mm diameter/ 4.0-14.2 mm wall*			
219 mm diameter/ 4.3-14.2 mm wall*			
250 mm diameter/ 5.0-14.2 mm wall*			
300 mm diameter/ 5.9-14.2 mm wall*			
324 mm diameter/ 6.35-14.2 mm wall*			

Pipe Diameter vs wall thickness

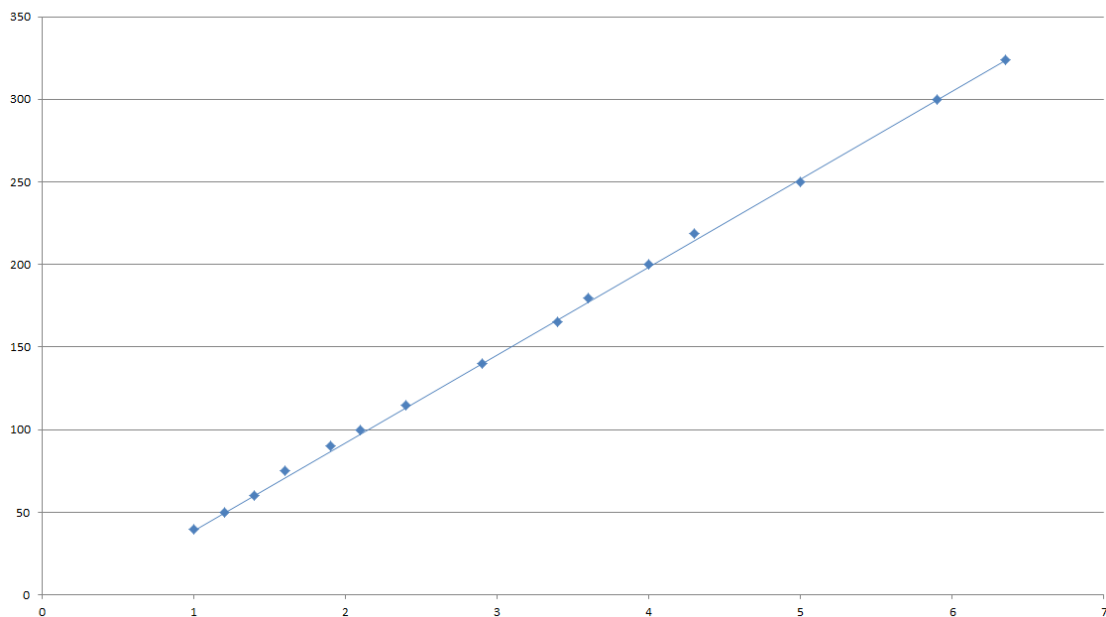



#### A.4.4 Pipe penetration seal with 2x Bostik FP 320 Fire Batt 1-S

**Penetration Seal:** CS (Continuous Sustained) insulated metallic pipes fitted at any position within the aperture, with 50 mm Bostik FP 320 Fire Batt 1-S to both sides of the wall. Bostik FP 340 Pipe Wraps are required to be fitted around the pipe insulation.

Construction details:

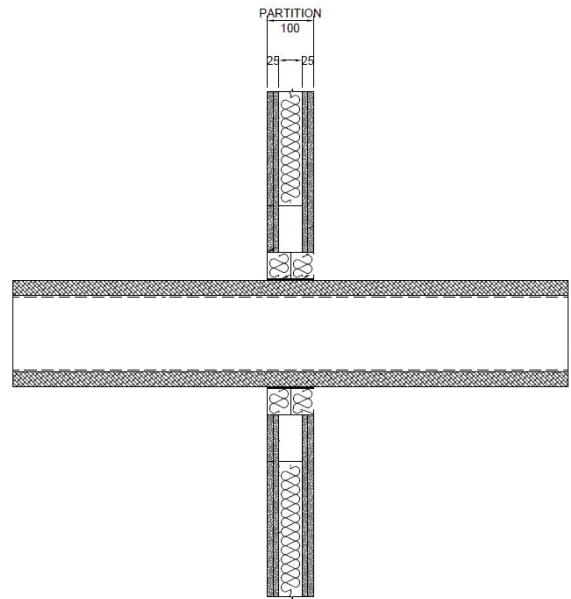
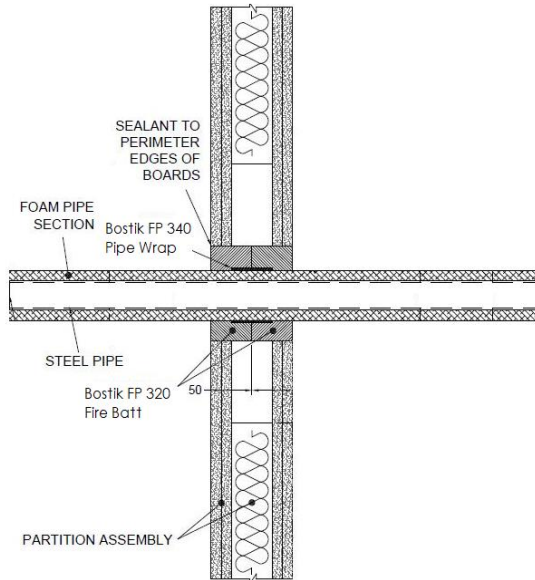

#### A.4.4.1 Two layer penetration seal with pipes

Services	Wrap	Insulation	Classification
Mild or stainless steel pipe			
40 mm diameter/1-14.2 mm wall	50 x 1.8 mm Bostik FP 340 Pipe Wrap fitted centrally	13 mm Kaiflex ST insulation	EI 120 U/C, EI 120 U/U, EI 120 C/U, EI 120 C/C
40 mm diameter/1-14.2 mm wall*	2 off 50 x 3.6 mm Bostik FP 340 Pipe Wrap, one fitted flush to each face of seal	13 - 32mm Kaiflex ST insulation	E 120 U/C, E 120 U/U, E 120 C/U, E 120 C/C, EI 60 U/C, EI 60 U/U, EI 60 C/U, EI 60 C/C
50 mm diameter/1.3-14.2 mm wall*			
60 mm diameter/1.6-14.2 mm wall*			
75 mm diameter/2-14.2 mm wall*			
90 mm diameter/2.4-14.2 mm wall*			
100 mm diameter/2.7-14.2 mm wall*			
115 mm diameter/3.1-14.2 mm wall*			
140 mm diameter/3.8-14.2 mm wall*			
165 mm diameter/ 4.5-14.2 mm wall*			

\* Typical pipe diameters shown, see below graph for intermediate sizes

Pipe diameter vs Wall thickness

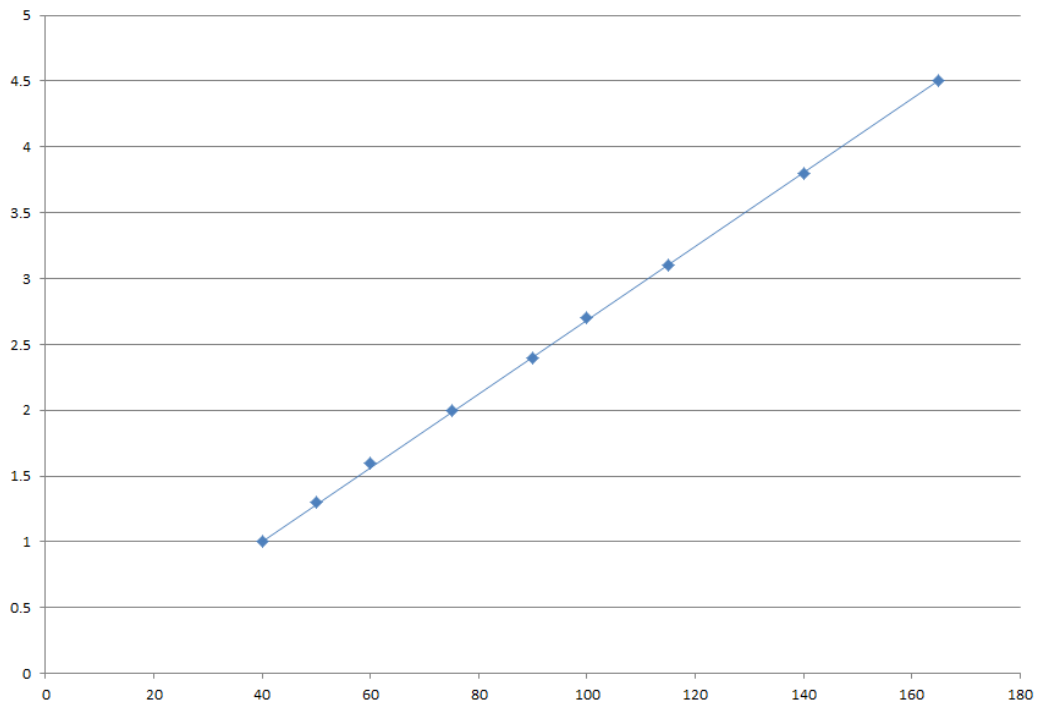

#### A.4.5 Pipe penetration seal with 2x Bostik FP 320 Fire Batt 1-S

**Penetration Seal:** 500 mm (min.)\* LI (Local Interrupted) or CI (Continuous Interrupted) insulated or uninsulated metallic and composite pipes (single) fitted at any position within the aperture, with 50 mm Bostik FP 320 Fire Batt 1-S to both sides of the wall.

Construction details:

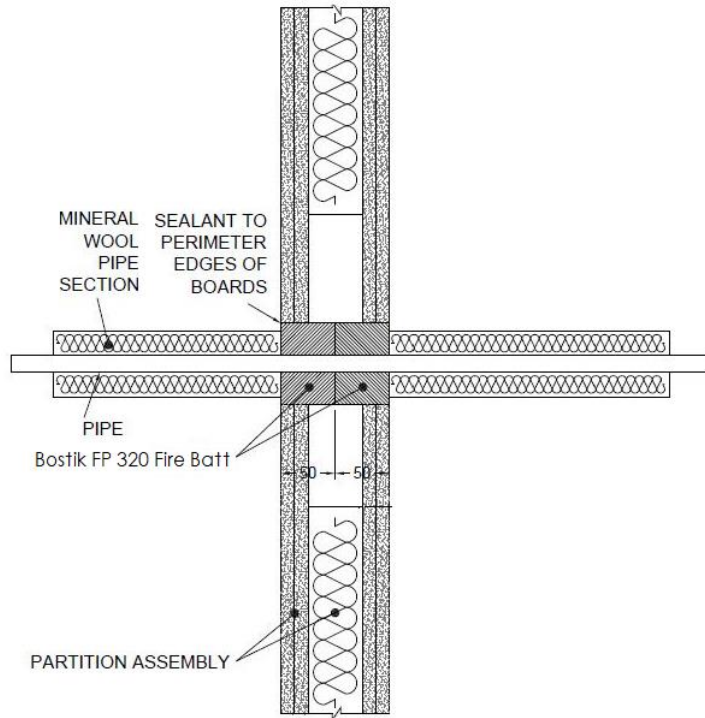

\* Minimum 600 mm long insulation required for Alupex pipe.

##### A.4.5.1 Two layer penetration seal with pipes

Services	Insulation	Classification
Copper pipe up to 54 mm diameter/1-14.2 mm wall	20 mm stone wool 80 kg/m <sup>3</sup>	EI 120 C/C
Alupex composite pipe 75 mm diameter/7.5 mm wall	600 mm length of 25 mm AES Fibre ≥ 128kg/m <sup>3</sup>	EI 60 C/U
Mild or stainless steel pipe 114 mm diameter/11 mm wall	None	E 90 C/U, EI 20 C/U

Services	Insulation	Classification
Mild or stainless steel pipe		
40 mm diameter/1-14.2 mm wall	20 mm stone wool 80 kg/m <sup>3</sup>	EI 120 C/U
40 mm diameter/1-14.2 mm wall*	30 mm stone wool 80 kg/m <sup>3</sup>	E 120 C/U, EI 90 C/U
50 mm diameter/1.2-14.2 mm wall*		
60 mm diameter/1.4-14.2 mm wall*		
75 mm diameter/1.7-14.2 mm wall*		
90 mm diameter/2-14.2 mm wall*		
100 mm diameter/2.2-14.2 mm wall*		
115 mm diameter/2.5-14.2 mm wall*		
140 mm diameter/3-14.2 mm wall*		
165 mm diameter/3.5-14.2 mm wall*		
180 mm diameter/3.8-14.2 mm wall*		
200 mm diameter/4.2-14.2 mm wall*		
219 mm diameter/4.5-14.2 mm wall*		

\* Typical pipe diameters shown, see below graph for intermediate sizes

Pipe diameter vs Wall thickness

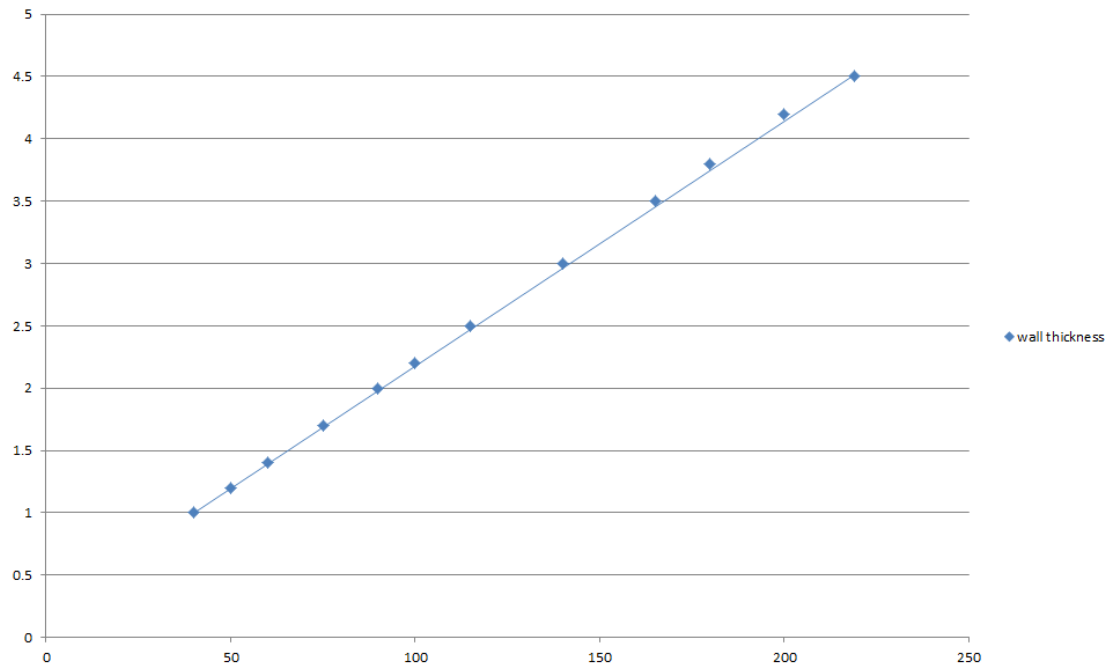

Services	Insulation (minimum)	Classification
Geberit Mepla MLC (PE-Xb/Aluminium/PE-HD) pipe*	20 mm stone wool 80 kg/m <sup>3</sup>	EI 120 C/C
16 mm diameter/2.25 mm wall		EI 60 C/C
20 mm diameter/2.5 mm wall		
26 mm diameter/3 mm wall		
32 mm diameter/3 mm wall		
40 mm diameter/3.5 mm wall		
50 mm diameter/4 mm wall		
63 mm diameter/4.5 mm wall		
75 mm diameter/4.7 mm wall		

#### A.4.6 Pipe penetration seal with 2x Bostik FP 320 Fire Batt 1-S

**Penetration Seal:** LS (Local Sustained) or CS (Continuous Sustained) insulated metallic and composite pipes (single) fitted at any position within the aperture, with 50 mm Bostik FP 320 Fire Batt 1-S to both sides of the wall. Bostik FP 340 Pipe Wraps are required to be fitted around the pipe to both sides of the seal.

Construction details:

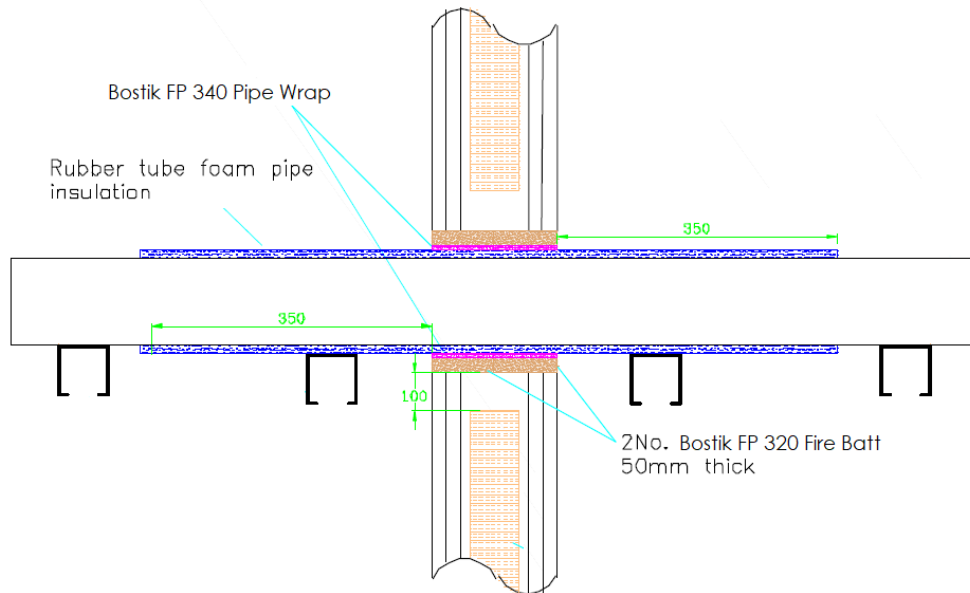

#### A.4.6.1 Two layer penetration seal with pipes

Services	Wrap	Insulation	Classification
Copper pipe			
12 mm diameter/1 mm wall	50 x 3.6 mm Bostik FP 340 Pipe Wrap fitted to both sides of the seal	9 mm Kaiflex ST insulation	<b>EI 120 C/C</b>
12-54 mm diameter/1-1.2 mm wall		9-13 mm Kaiflex ST insulation	<b>E 120 C/C, EI 90 C/C</b>
12-54 mm diameter/1-1.2 mm wall		13-25 mm Kaiflex ST insulation	<b>E 120 C/C, EI 60 C/C</b>
Geberit Mepla MLC (PE-Xb/Aluminium/PE-HD pipe)*			
16 mm diameter/2.25 mm wall	50 x 3.6 mm Bostik FP 340 Pipe Wrap fitted to both sides of the seal	9-25 mm Kaiflex ST insulation	<b>EI 120 C/C</b>
20 mm diameter/2.5 mm wall			
26 mm diameter/3 mm wall			
32 mm diameter/3 mm wall			
40 mm diameter/3.5 mm wall			
50 mm diameter/4 mm wall			
63 mm diameter/4.5 mm wall			
75 mm diameter/4.7 mm wall			

#### A.4.7 Plastic pipe penetration seal with 2x Bostik FP 320 Fire Batt 1-S

**Penetration Seal:** Combustible pipes (single) fitted central within the aperture, with Bostik FP 320 Fire Batt 1-S to both sides of the wall. Bostik FP 340 Pipe Wraps are required to be fitted around the pipe.

Construction details:

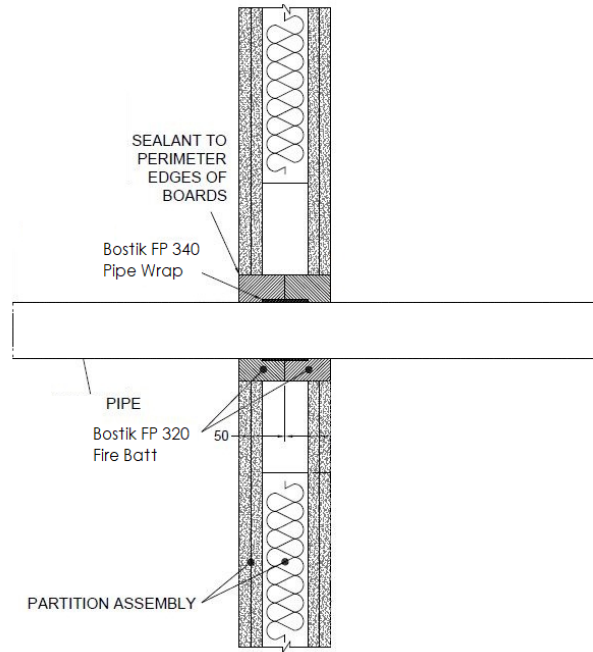

##### A.4.7.1 Two layer penetration seal with pipes

Services	Pipe Wrap	Classification
PVC-U pipe according to EN 1329-1, EN 1452-1 and EN 1453-1 315 mm Ø/9.2 mm wall	Bostik FP 340 Pipe Wrap 75 x 18 mm fitted centrally around the pipe	EI 45 C/C



#### A.4.8 Cable penetration seal with 1x Bostik FP 320 Fire Batt 50 2-S in framed aperture

**Penetration Seal:** Cables fitted at any position within the aperture, with 50 mm Bostik FP 320 Fire Batt 2-S positioned to either face of the wall (or anywhere in between). Minimum 30 mm separation between pipes. Bostik FP 330 Pipe Collar fixed with penetrating threaded rod and nuts. Cables and cable trays coated 150mm each side of Bostik FP 320 Fire Batt with nominally 300µm WFT Bostik FP380 Service Coating

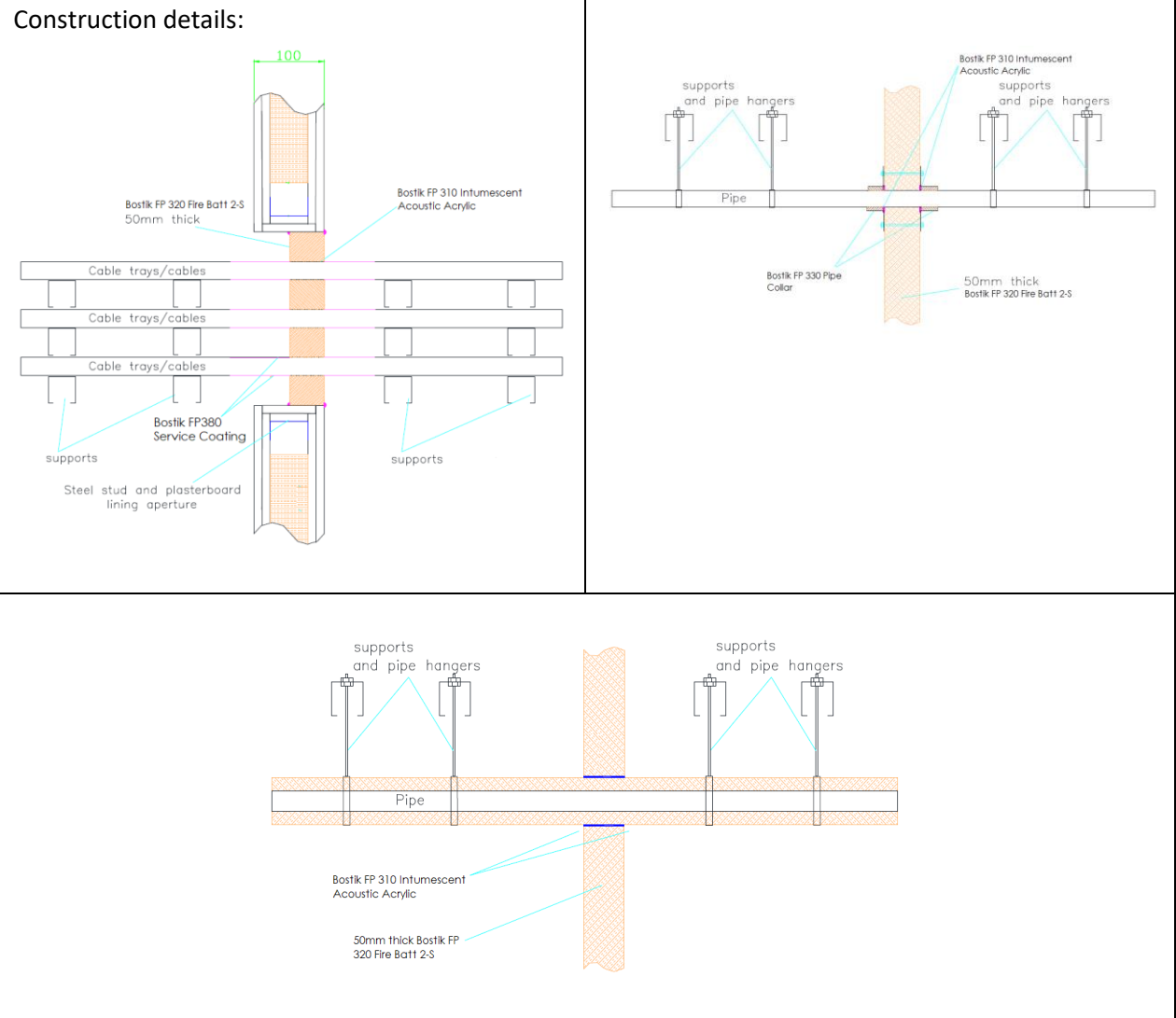

##### A.4.8.1 Single side penetration seal with cables and pipes

Services	Maximum aperture	Classification
Electrical cables up to 80 mm Ø (single, bundled and on trays)	1200 mm wide x 600 mm high	EI 60
Cables up to 21mm Ø in tied bundles up to 100mm Ø		EI 60
Perforated Steel cable trays & ladders		E 60, EI 45
Unperforated steel cable trays		E 60, EI 45
Unsheathed wires up to 24 mm Ø		E 60, EI 45

Services	Maximum Aperture	Insulation CS	Classification
Mild or stainless steel pipe			
40 mm diameter/1.0-14.2 mm wall*	1200 mm wide x 600 mm high	20 mm Stone wool insulation 80 kg/m <sup>3</sup>	E 90 C/U, EI 60 C/U
40 mm diameter/1.0-14.2 mm wall*		30 mm Stone wool insulation 80 kg/m <sup>3</sup>	
50 mm diameter/1.7-14.2 mm wall*			
60 mm diameter/1.8-14.2 mm wall*			
75 mm diameter/2.1-14.2 mm wall*			
90 mm diameter/2.3-14.2 mm wall*			
100 mm diameter/2.5-14.2 mm wall*			
115 mm diameter/2.8-14.2 mm wall*			
140 mm diameter/3.2-14.2 mm wall*			
165 mm diameter/ 3.6-14.2 mm wall*			
180 mm diameter/ 3.9-14.2 mm wall*			
200 mm diameter/ 4.2-14.2 mm wall*			
219 mm diameter/ 4.5-14.2 mm wall*			
250 mm diameter/ 5.0-14.2 mm wall*			
300 mm diameter/ 5.9-14.2 mm wall*			
324 mm diameter/ 6.35-14.2 mm wall*			

\* Typical pipe diameters shown, see below graph for intermediate sizes

CS – Continuous Sustained

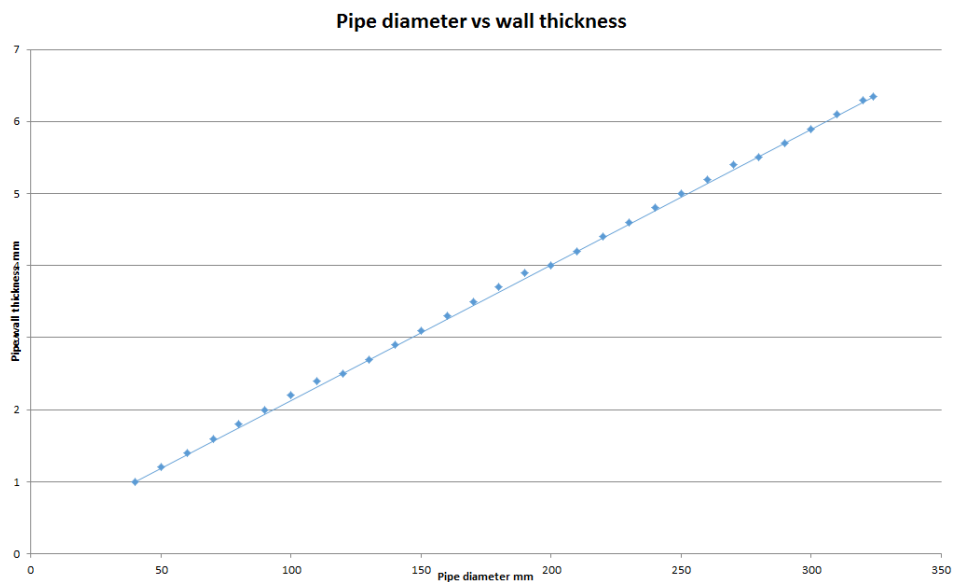

<b>Services</b>	<b>Collar Inlay</b>	<b>Classification</b>
PVC-U pipe according to EN 1329-1, EN 1452-1 and EN 1453-1 and PVC-C according to EN 1566-1		
Diameter 32 mm, wall thickness 1.9 mm	30 x 2.4 mm	<b>E 90 U/C, EI 45 U/C</b>
Diameter 40 mm, wall thickness 1.9 mm		
Diameter 50 mm, wall thickness 3.7-6.6 mm	30 x 3.0 mm	<b>E 90 U/C, EI 30 U/C</b>
Diameter 55 mm, wall thickness 3.7-6.6 mm	30 x 3.2 mm	
Diameter 63 mm, wall thickness 3.7-6.6 mm	30 x 4.0 mm	
Diameter 75 mm, wall thickness 3.7-6.6 mm	30 x 4.2 mm	
Diameter 82 mm, wall thickness 3.7-6.6 mm	30 x 5.0 mm	
Diameter 90 mm, wall thickness 3.7-6.6 mm		
Diameter 110 mm, wall thickness 3.7-6.6 mm	30 x 6.0 mm	

<b>Services</b>	<b>Collar Inlay</b>	<b>Classification</b>
PE pipe according to EN 1519-1, EN 12201-2 and EN 12666-1, ABS according to EN 1455-1 and pipes made from SAN+PVC according to EN 1565-1		
Diameter 32 mm, wall thickness 3.4-10.0 mm	30 x 3.0 mm	<b>E 60 U/C, EI 45 U/C</b>
Diameter 40 mm, wall thickness 3.4-10.0 mm		
Diameter 50 mm, wall thickness 3.4-10.0 mm		
Diameter 55 mm, wall thickness 3.4-10.0 mm	30 x 3.2 mm	
Diameter 63 mm, wall thickness 3.4-10.0 mm	30 x 4.0 mm	
Diameter 75 mm, wall thickness 3.4-10.0 mm	30 x 4.2 mm	
Diameter 82 mm, wall thickness 3.4-10.0 mm	30 x 5.0 mm	
Diameter 90 mm, wall thickness 3.4-10.0 mm		
Diameter 110 mm, wall thickness 3.4-10.0 mm	30 x 6.0 mm	